

INSTALLATION INSTRUCTION
ISTRUZIONI DI MONTAGGIO
INSTALLATIONSANLEITUNG
INSTRUCTIONS D'INSTALLATION
INSTRUCCIONES DE MONTAJE

TICTOK ZOOM 45 / 58 / 75
EVO 48V Track

48V Low Voltage Track Lighting

Lampada per binari a basso voltaggio 48V

48V Low-Voltage-Schienensysteme Leuchten

Éclairage de voie basse tension 48V

Luminarias de pista de bajo voltage 48V

Art.

96A6

96A7

96C5

96C6

9668

9669

For Art. 96A6, 96A7, 9668

For Art.96C5, 96C6, 9669

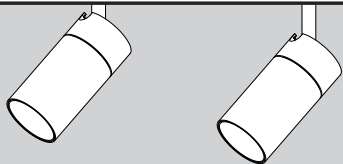

Die Installation muss nach den gültigen Sicherheitsvorschriften durch einen konzessionierten Elektroinstallateur erfolgen.

L'installation doit être réalisée par un électricien qualifié en respectant les prescriptions en vigueur.

La instalación debe ser realizada por una persona cualificada y de acuerdo a la normativa vigente.

3. Use this light fixture at the rated voltage and frequency as indicated on the specification table.

Utilizzare questo apparecchio a tensione e frequenza indicate nella tabella.

Die Leuchte darf nur mit der angegebenen Spannung und Frequenz betrieben werden.

Respecter les prescriptions de tension et de fréquence indiquées dans le tableau final.

Utilice esta lámpara a la tensión y frecuencia indicadas en las instrucciones.

4. This installation manual must be retained by the person responsible for the installation and maintenance of the product.

Queste istruzioni di montaggio devono essere conservate dal responsabile dell'installazione e manutenzione dell'apparecchio.

Bewahren Sie diese Gebrauchsanweisung für den verantwortlichen Benutzer / Wartungstechniker auf.

Gardez cette instruction pour l'utilisateur / technicien de maintenance.

Estas instrucciones deben ser conservadas por el responsable de mantenimiento de la instalación.

CAUTIONS

AVVERTENZE, WARNUNG
PRECAUTIONS, PRECAUCIONES

1. Switch-off the power supply before any installation and maintenance operations.
Use only a two-pole switch

Staccare la linea elettrica prima dell'installazione e di ogni intervento di manutenzione.
Utilizzare un interruttore bipolare

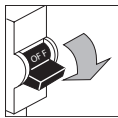

Die Stromzufuhr muss vor der Installation / Wartung ausgechaltet werden.
Nur mit einem zweipoligen Stecker zu verwenden

Couper la source d'alimentation avant toute installation et opération d'entretien.
Seulement utiliser avec un connecteur bipolaires

No efectuar la conexión de la lámpara con la tensión general activada.
Usar un interruptor bipolar

2. Installation must be carried out only by qualified personnel according to safety norms and local regulations.

L'installazione deve essere effettuata da personale qualificato secondo la normativa elettrica vigente.

INSTALLATION

INSTALLAZIONE, MONTAGE, INSTALLATION, INSTALACIÓN

1

Track Type Compatibility

Tipi di binari compatibili, Stromschienen Type-Kompatibilität
Compatibilitat des types de pistes, Compatibilitat con el tipo de pista

For Art.96A6, 96A7, 9668
TicTok Zoom EVO 48V

Surface Track
2ST1



Surface Track
Pendant Track
2ST6



Deep Pendant Track
For Up Side
2ST9

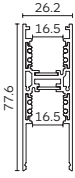

Pendant Track
For Up & Down
2ST7

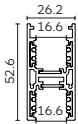

Recessed Track
Trim
2ST8



Recessed Track Trimless
2ST3



For Art.96C5, 96C6, 9669
TicTok Zoom Long Arm
EVO 48V

Deep Surface Track
Deep Pendant Track
2ST2

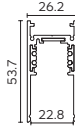

Deep Pendant Track
For Up & Down
2ST9

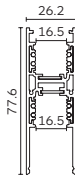

Deep Recessed Track
Trimless
2ST5

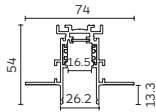

Deep Recessed Track
Trimless
2ST4

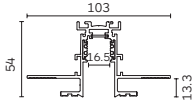

2

For Art.96A6, 96A7, 9668



For Art.96C5, 96C6, 9669

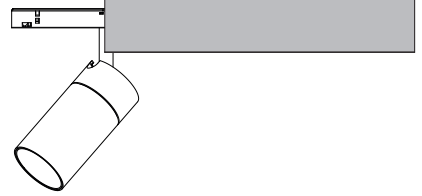

3

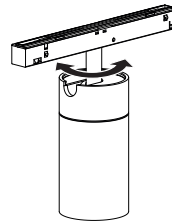

4

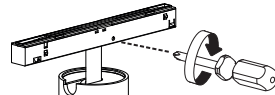

* For TicTok Zoom 45 / 58 / 75 EVO 48V

5

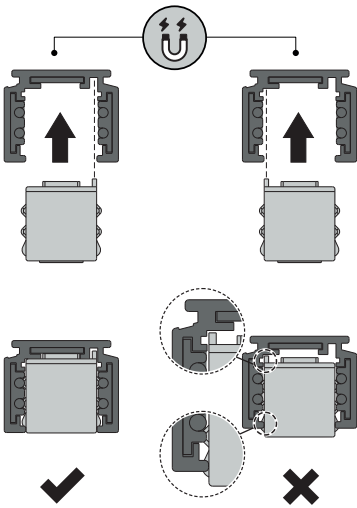
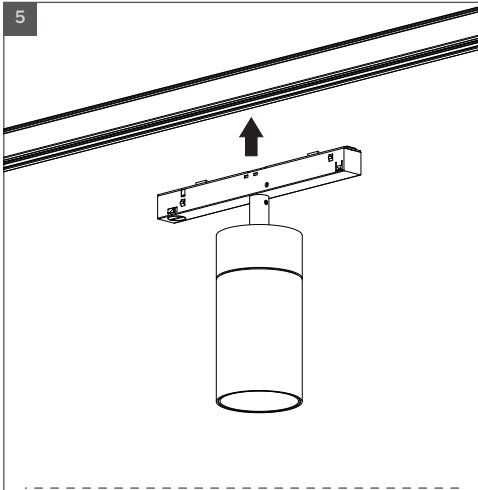

6

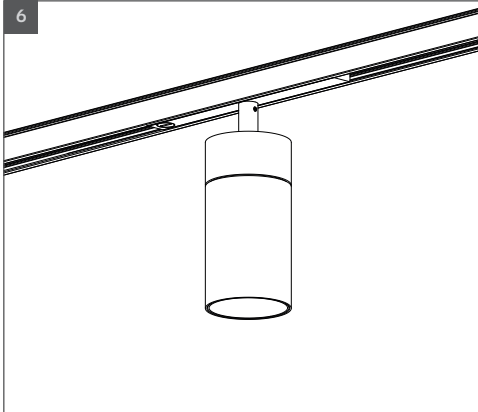

7

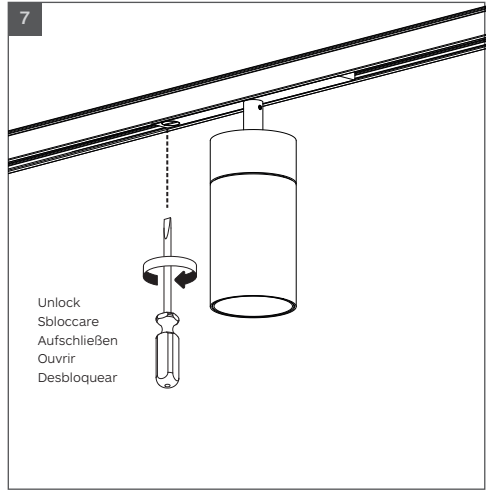

Unlock
Sbloccare
Aufschließen
Ouvrir
Desbloquear

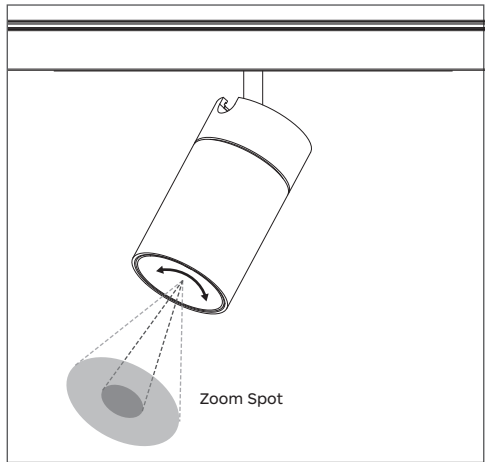

ANGLE ADJUSTMENT

ORIENTAMENTO DEL VANO OTTICO,
ORIENTUNG DER OPTISCHEN,
ORIENTATION DU GROUPE OPTIQUE,
ORIENTABILIDAD DE LA OPTICA

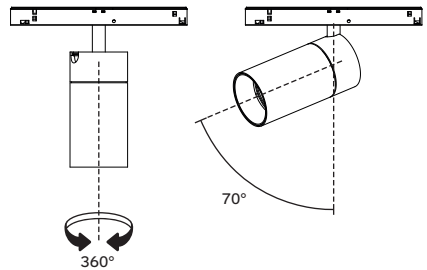

MEASUREMENTS

DIMENSIONI, ABMESSUNGEN,
DIMENSIONS, MEDIDAS

in mm

TicTok 45 Zoom
Art.: 96A6

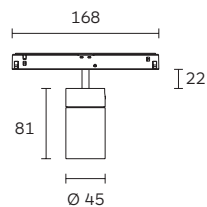

TicTok Zoom 45 Long Arm
Art.: 96C5

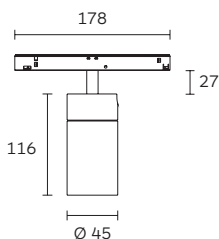

TicTok 58 Zoom
Art.: 96A7

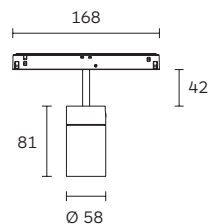

TicTok Zoom 58 Long Arm
Art.: 96C6

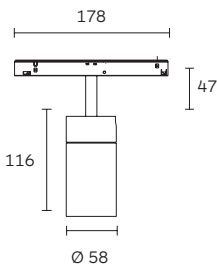

TicTok 75 Zoom
Art.: 9668

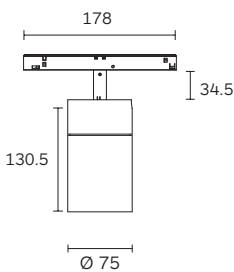

TicTok Zoom 75 Long Arm
Art.: 9669

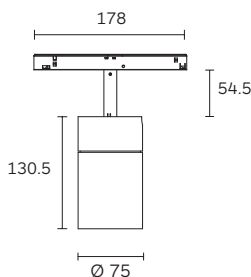

SPECIFICATION

CARATTERISTICHE, BESCHREIBUNG,
CARACTERISTIQUES, ESPECIFICACIONES

Art.	Max Wattage(W)	Voltage (V)	Lamp	Remarks	Class
96A6 96C5	6	48	LED	*	
96A7 96C6	15	48	LED	*	
9668 9669	19	48	LED	*	

* LED and LED driver included.
LED e alimentatore compresi.
Inklusive LED und LED Driver.
LED et driver LED inclus.
LED y alimentador incluidos.

For LED replacement, please contact us.

Per rimpiazzare il LED, la preghiamo di contattarci.

Pour le remplacement de LED, s'il vous plait contactez-nous.

Zum Austausch des LEDs, bitte setzen Sie in Verbindung mit uns.

Para reemplazar el LED, por favor contacte con nosotros.



formalighting

Forma Lighting (Italia) S.r.l.

T: (+39) 02 9354 0300

F: (+39) 02 9343 5117

E: formaitalia@formalighting.it

Address: Via Europa, 35/A

20005 Pogliano Mil.se MI

Forma Lighting (HK) Ltd.

T: (+852) 2516 6500

F: (+852) 2516 6525

E: forma@forma.com.hk

Address: Room 4, 5/F.,

Eastern Harbour Centre

28 Hoi Chak Street

Quarry Bay, Hong Kong

