

# Cobra Flex

Designed by Ponctuelle



## Body

Surface mounted modular system in extruded aluminium.  
Available in different length configurations based on a 54mm link (2 LED per link) with a 60mm increment.  
Section 28.5x30mm.  
Its flexible structure maintain a constant 30mm pitch between the LED.

Mounting options:  
U mounting clips.

**\* Plastic free packaging.**

## Accessories

Honeycomb Art. 2D88.  
Color filter Art. 2E40.  
Mounting accessories included.  
Power extension cable Art. 2C47 to be ordered separately.

## Finish

Anodized black, white, brass polished or gold finish.  
Other finish options available on request.

## LED sources

Power LED.  
CRI: 75 & 90 | R9: >90 | CCT: 2100K, 2400K, 2700K, 3000K, 3500K, 4000K.  
3-Step MacAdam.  
Other CRI and CCT options available on request.

## Optic

Lens.  
Beam angle: 10° / 17° / 29° / elliptical (15° x 50°).  
Wallwasher optics.

## Driver

Driver not included to be ordered separately.  
Work with 1050 mA Constant Current Driver positioned remotely.

## Applications

Ideal for indirect cove illumination, it creates a wall grazing effect for columns and curved architectonic surfaces. Its flexible structure maintain a constant pitch between LED, insuring a continuous illumination without any shadows or dark areas. Application areas: Cove light, wallwash, residential, hospitality, restaurants, museums.

### Related Products

**Cobra Linealuce** 

**Cobra Flex Chain** 

**Cobra Linealuce Louvre** 

**Cobra Flex Louvre** 

**Cobra Flex Chain Louvre** 

**Cobra Pro IP66** 



# Cobra Flex | G401

**Cobra**  
Flex



## Min. L= 54mm (2 x LED) 1 Link

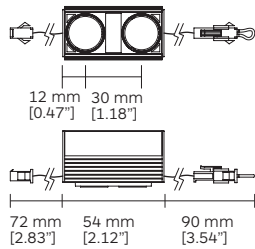

## Mounting options

With mounting U clip

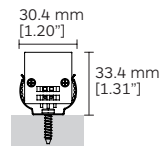

## Accessories

Honeycomb Art. 2D88

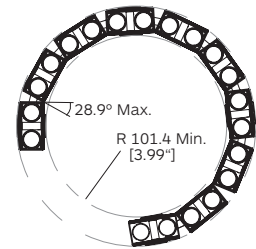
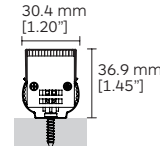

## Max. L= 954mm (32 x LED) 16 Links

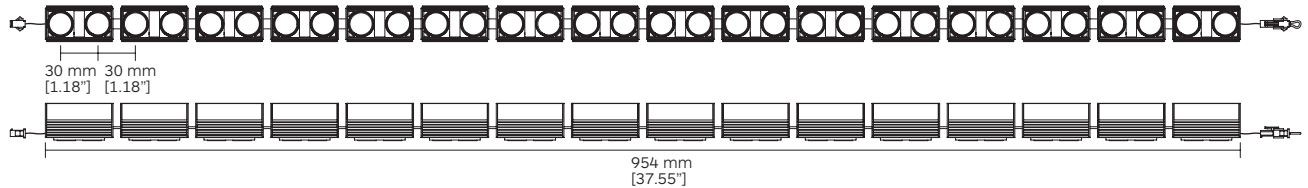

## Available length codes <sup>1</sup>

No. of Links	Voltage	LED Power	Length code	Length in mm	Length in inches	Nominal Lumen	No. of Links	Voltage	LED Power	Length code	Length in mm	Length in inches	Nominal Lumen
1	3.3V	3.1W	<b>0054</b>	54	2.12	366 lm	9	29.7V	28.3W	<b>0534</b>	534	21.02	3294 lm
2	6.6V	6.3W	<b>0114</b>	114	4.48	732 lm	10	33V	31.5W	<b>0594</b>	594	23.38	3660 lm
3	9.9V	9.4W	<b>0174</b>	174	6.85	1098 lm	11	36.3V	34.6W	<b>0654</b>	654	25.74	4026 lm
4	13.2V	12.6W	<b>0234</b>	234	9.21	1464 lm	12	39.6V	37.8W	<b>0714</b>	714	28.11	4392 lm
5	16.5V	15.7W	<b>0294</b>	294	11.57	1830 lm	13	42.9V	40.9W	<b>0774</b>	774	30.47	4758 lm
6	19.8V	18.9W	<b>0354</b>	354	13.93	2196 lm	14	46.2V	44.1W	<b>0834</b>	834	32.83	5124 lm
7	23.1V	22W	<b>0414</b>	414	16.29	2562 lm	15	49.5V	47.2W	<b>0894</b>	894	35.19	5490 lm
8	26.4V	25.2W	<b>0474</b>	474	18.66	2928 lm	16	52.8V	50.4W	<b>0954</b>	954	37.55	5856 lm

Code ordering example: **G 4 0 1 0 0 5 4 - 9 0 2 7 1 0 0 0 1 0**

	Product code*	Length code	>CRI	CCT**	LED Power	Nominal Lumen	Beam angle (BA°)	Driver Options	Finish
Cobra Flex	<b>G401</b>	Min. <b>0054</b>	<b>90</b>	<b>27</b> 2700K	1.5W/LED	183lm/LED	<b>10 / 17 / 29 / EL / WW</b>	<b>00</b> No Driver	<b>10</b> ■ Black
		⋮		<b>30</b> 3000K					<b>11</b> □ White
		Max. <b>0954</b>		<b>35</b> 3500K					<b>28</b> ■ Brass Polished
				<b>40</b> 4000K					<b>35</b> ■ Gold
			<b>75</b>	<b>21</b> 2100K		173lm/LED			
				<b>24</b> 2400K					

### Notes:

<sup>1</sup> Information in the chart above is related to 3000K LED.

# Driver Options

## Constant Current

### Cobra Flex

2C02 Constant Current LED Driver. 1 Driver can drive 2-32LEDs, about 954mm Max.

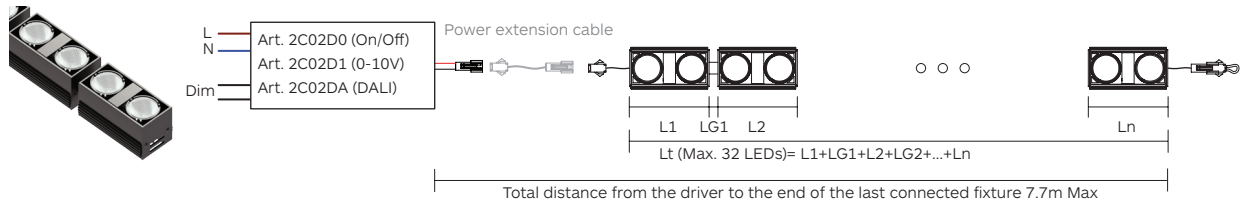

### G401

Power extension cable. Art. **2C47**. 1m (if necessary).

Vin= 180~277V AC 50/60Hz  
 Iout= 1050mA V=2~57V  
 P= 60W Max.  
 Dimensions: 123.5x81.5x23mm  
 IP20

# Accessories



Honeycomb

Finish: 10

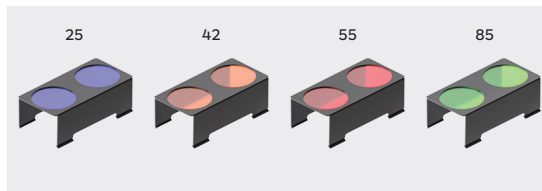

Coloured Filters

Filter colour codes: 25 / 42 / 55 / 85

Product / Accessories

Cobra Flex

**2D88**

**2E40-25**  
**2E40-42**  
**2E40-55**  
**2E40-85**

\* Please refer to the user manuals for further details.

# Cobra Flex Chain

Adjustable in 3 directions

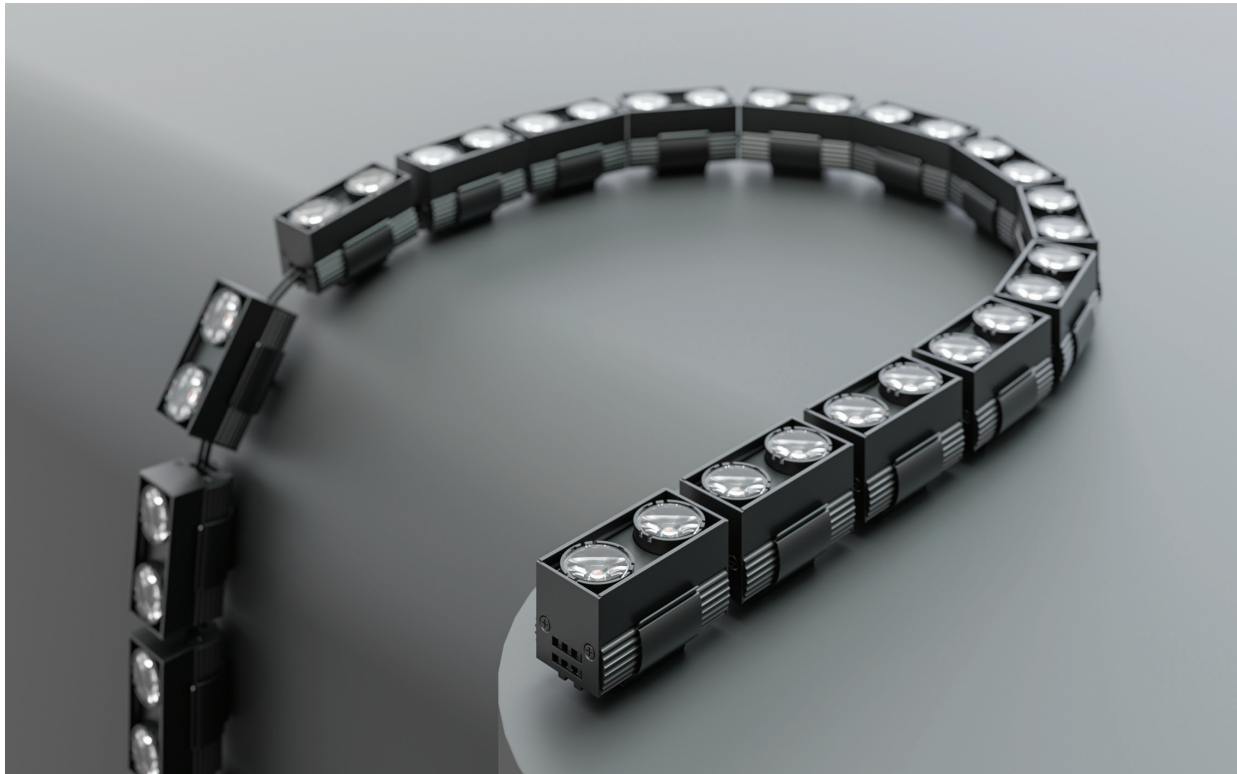

## Body

Surface mounted modular system in extruded aluminium, LED links connected by a steel wire enabling adjustment of each individual LED link in 3 directions.

Available in different length configurations based on a 54mm link (2 LED per link) with a 64mm increment. Section 28.5 x 30mm. Its flexible structure maintain a constant 30mm pitch between the LED.

Mounting options:  
U mounting clips.

**\* Plastic free packaging.**

## Accessories

Honeycomb Art. 2D88.  
Color filter Art. 2E40.  
Mounting accessories included.  
Power extension cable Art. 2C47 to be ordered separately.

## Finish

Anodized black, white, brass polished or gold finish.  
Other finish options available on request.

## LED sources

Power LED.  
CRI: 75 & 90 | R9: >90 | CCT: 2100K, 2400K, 2700K, 3000K, 3500K, 4000K.  
3-Step MacAdam.  
Other CRI and CCT options available on request.

## Optic

Lens.  
Beam angle: 10° / 17° / 29° / elliptical (15° x 50°).  
Wallwasher optics.

## Driver

Driver not included to be ordered separately.  
Work with 1050 mA Constant Current Driver positioned remotely.

## Applications

Ideal for indirect cove illumination, it creates a wall grazing effect for columns and curved architectonic surfaces. Its flexible structure maintain a constant pitch between LED, insuring a continuous illumination without any shadows or dark areas. Application areas: Cove light, wallwash, residential, hospitality, restaurants, museums.

## Related Products

**Cobra Linealuce** 

**Cobra Flex** 

**Cobra Linealuce Louvre** 

**Cobra Flex Louvre** 

**Cobra Flex Chain Louvre** 

**Cobra Pro IP66** 



# Cobra Flex Chain | G472

**Cobra**  
Flex Chain



## Min. L= 54mm (2 x LED) 1 Link

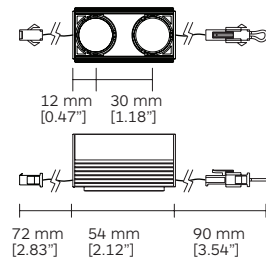

## Mounting options

With mounting U clip

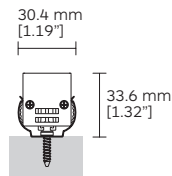

## Accessories

Honeycomb Art. 2D88

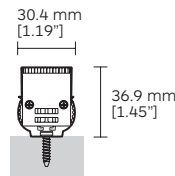

## Adjustable

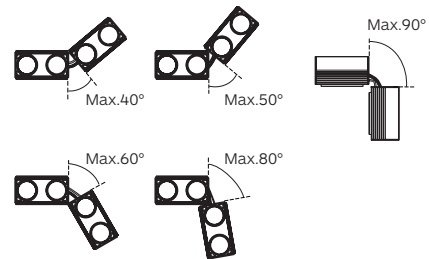

## Max. L= 1014mm (32 x LED) 16 Links

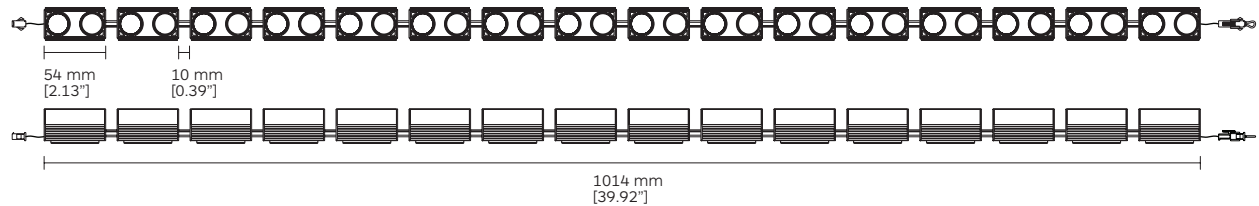

## Available length codes <sup>1</sup>

No. of Links	Voltage	LED Power	Length code	Length in mm	Length in inches	Nominal Lumen	No. of Links	Voltage	LED Power	Length code	Length in mm	Length in inches	Nominal Lumen
1	3.3V	3.1W	<b>0054</b>	54	2.12	366 lm	9	29.7V	28.3W	<b>0566</b>	566	22.28	3294 lm
2	6.6V	6.3W	<b>0118</b>	118	4.65	732 lm	10	33V	31.5W	<b>0630</b>	630	24.80	3660 lm
3	9.9V	9.4W	<b>0182</b>	182	7.17	1098 lm	11	36.3V	34.6W	<b>0694</b>	694	27.32	4026 lm
4	13.2V	12.6W	<b>0246</b>	246	9.69	1464 lm	12	39.6V	37.8W	<b>0758</b>	758	29.84	4392 lm
5	16.5V	15.7W	<b>0310</b>	310	12.20	1830 lm	13	42.9V	40.9W	<b>0822</b>	822	32.36	4758 lm
6	19.8V	18.9W	<b>0374</b>	374	14.72	2196 lm	14	46.2V	44.1W	<b>0886</b>	886	34.88	5124 lm
7	23.1V	22W	<b>0438</b>	438	17.24	2562 lm	15	49.5V	47.2W	<b>0950</b>	950	37.40	5490 lm
8	26.4V	25.2W	<b>0502</b>	502	19.76	2928 lm	16	52.8V	50.4W	<b>1014</b>	1014	39.92	5856 lm

Code ordering example: **G 4 7 2 0 0 5 4 - 9 0 2 7 1 0 0 0 1 0**

	Product code*	Length code	>CRI	CCT**	LED Power	Nominal Lumen	Beam angle (BA°)	Driver Options	Finish	
Cobra Flex Chain	<b>G472</b>	Min. <b>0054</b>	<b>90</b>	<b>27</b> 2700K	1.5W/LED	183lm/LED	<b>10 / 17 / 29 / EL / WW</b>	<b>00</b> No Driver	<b>10</b> ■ Black	
		⋮		<b>30</b> 3000K					<b>11</b> □ White	
		Max. <b>1014</b>		<b>35</b> 3500K					<b>28</b> ■ Brass Polished	
				<b>40</b> 4000K					<b>35</b> ■ Gold	
				<b>75</b> <b>21</b> 2100K					173lm/LED	
				<b>24</b> 2400K						

## Notes:

<sup>1</sup> Information in the chart above is related to 3000K LED.

# Driver Options

## Constant Current

### Cobra Flex Chain

2C02 Constant Current LED Driver. 1 Driver can drive 2-32LEDs, about 954mm Max.

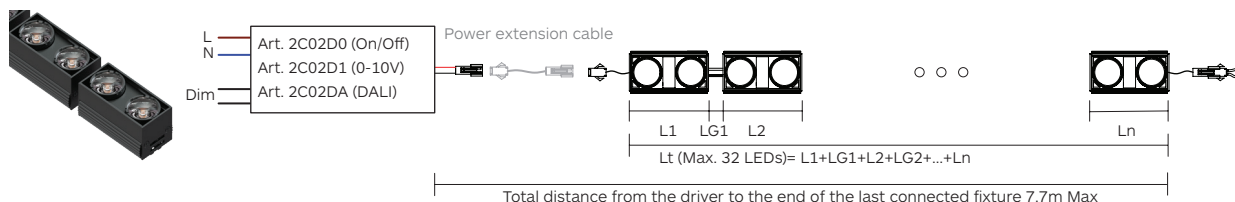

**G472**

Power extension cable. Art. **2C47**. 1m (if necessary).

Vin= 180-277V AC 50/60Hz  
 Iout= 1050mA V=2~57V  
 P= 60W Max.  
 Dimensions: 123.5x81.5x23mm  
 IP20

# Accessories

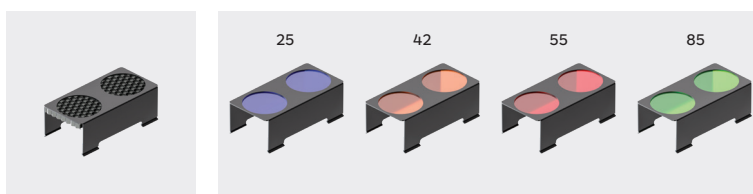

Product / Accessories

Honeycomb

Coloured  
Filters

Finish: 10

Filter colour codes: 25 / 42 / 55 / 85

Cobra Flex Chain

**2D88**

**2E40-25**  
**2E40-42**  
**2E40-55**  
**2E40-85**

\* Please refer to the user manuals for further details.

# Cobra Flex Chain Louvre

Adjustable in 3 directions

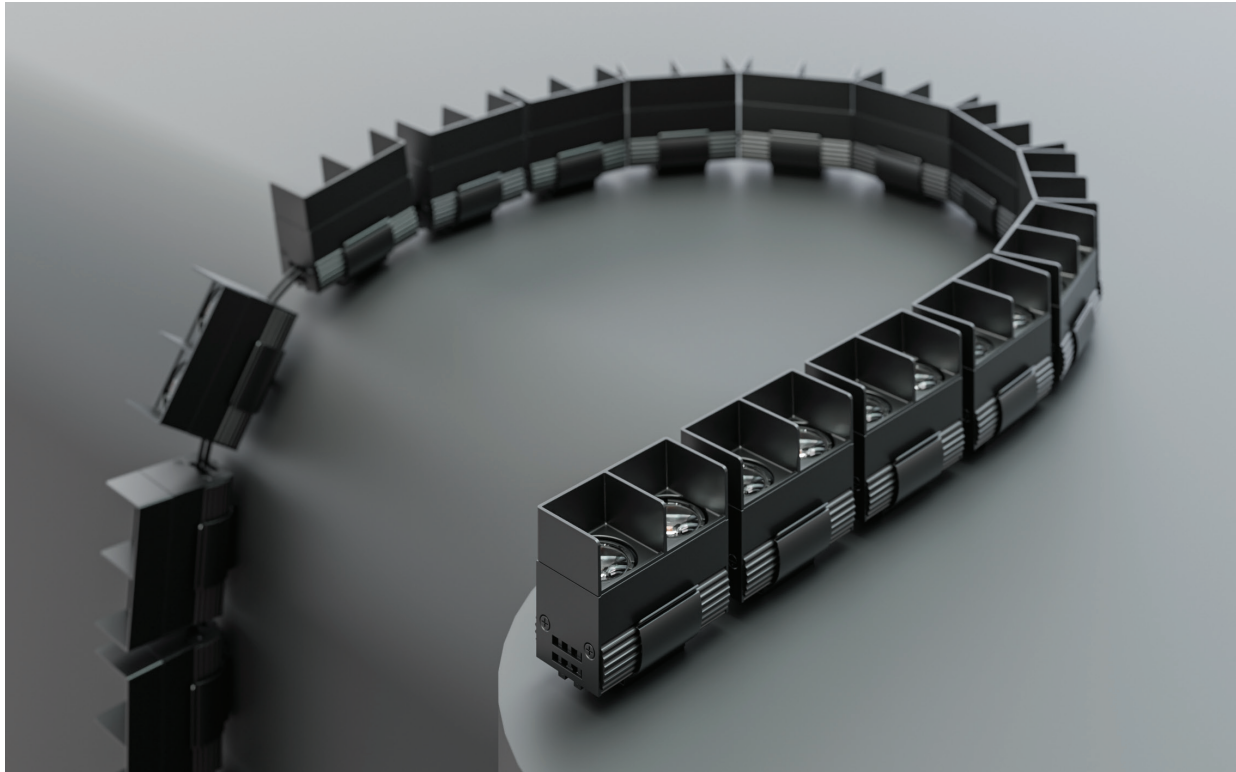

## Body

Surface mounted modular system in extruded aluminium, LED links connected by a steel wire enabling adjustment of each individual LED link in 3 directions.

Available in different length configurations based on a 54mm link (2 LED per link) with a 64mm increment. Section 28.5 x 30mm. Its flexible structure maintain a constant 30mm pitch between the LED. Integrated louvre.

Mounting options:  
U mounting clips.

**\* Plastic free packaging.**

## Accessories

Mounting accessories included.  
Power extension cable Art. 2C47 to be ordered separately.

## Finish

Anodized black, white, brass polished or gold finish.  
Other finish options available on request.

## LED sources

Power LED.  
CRI: 75 & 90 | R9: >50 | CCT: 2100K, 2400K, 2700K, 3000K, 3500K, 4000K.  
3-Step MacAdam.  
Other CRI and CCT options available on request.

## Optic

Lens.  
Beam angle: 10° / 17° / 29° / elliptical (15° x 50°).  
Wallwasher optics.

## Driver

Driver not included to be ordered separately.  
Work with 1050 mA Constant Current Driver positioned remotely.

## Applications

Ideal for indirect cove illumination, it creates a wall grazing effect for columns and curved architectonic surfaces. Its flexible structure maintain a constant pitch between LED, insuring a continuous illumination without any shadows or dark areas. Application areas: Cove light, wallwash, residential, hospitality, restaurants, museums.

## Related Products

**Cobra Linealuce** 

**Cobra Flex** 

**Cobra Flex Chain** 

**Cobra Linealuce Louvre** 

**Cobra Flex Louvre** 

**Cobra Pro IP66** 



# Cobra Flex Chain Louvre | G473

**Cobra**  
Flex Chain  
Louvre



**Min. L= 54mm (2 x LED) 1 Link**

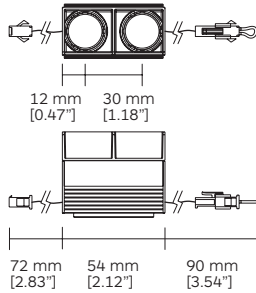

**Mounting options**

With mounting U clip

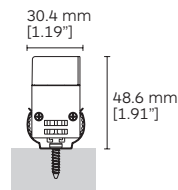

**Adjustable**

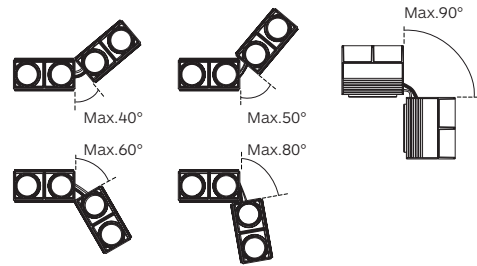

**Max. L= 1014mm (32 x LED) 16 Links**

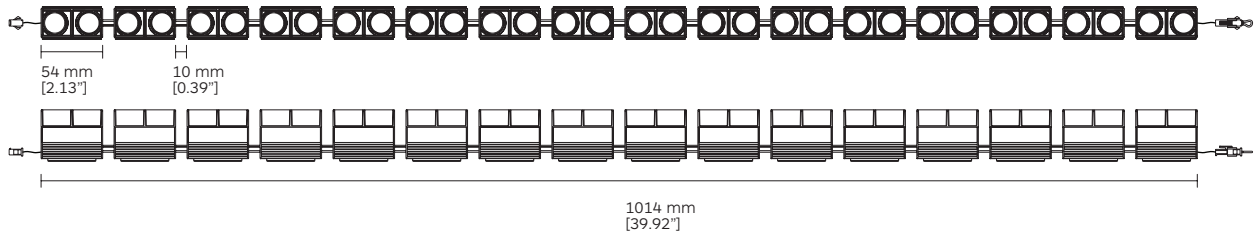

**Available length codes <sup>1</sup>**

No. of Links	Voltage	LED Power	Length code	Length in mm	Length in inches	Nominal Lumen	No. of Links	Voltage	LED Power	Length code	Length in mm	Length in inches	Nominal Lumen
1	3.3V	3.1W	<b>0054</b>	54	2.12	366 lm	9	29.7V	28.3W	<b>0566</b>	566	22.28	3294 lm
2	6.6V	6.3W	<b>0118</b>	118	4.65	732 lm	10	33V	31.5W	<b>0630</b>	630	24.80	3660 lm
3	9.9V	9.4W	<b>0182</b>	182	7.17	1098 lm	11	36.3V	34.6W	<b>0694</b>	694	27.32	4026 lm
4	13.2V	12.6W	<b>0246</b>	246	9.69	1464 lm	12	39.6V	37.8W	<b>0758</b>	758	29.84	4392 lm
5	16.5V	15.7W	<b>0310</b>	310	12.20	1830 lm	13	42.9V	40.9W	<b>0822</b>	822	32.36	4758 lm
6	19.8V	18.9W	<b>0374</b>	374	14.72	2196 lm	14	46.2V	44.1W	<b>0886</b>	886	34.88	5124 lm
7	23.1V	22W	<b>0438</b>	438	17.24	2562 lm	15	49.5V	47.2W	<b>0950</b>	950	37.40	5490 lm
8	26.4V	25.2W	<b>0502</b>	502	19.76	2928 lm	16	52.8V	50.4W	<b>1014</b>	1014	39.92	5856 lm

Code ordering example: **G 4 7 3 0 0 5 4 - 9 0 2 7 1 0 0 0 1 0**

	Product code*	Length code	>CRI	CCT**	LED Power	Nominal Lumen	Beam angle (BA°)	Driver Options	Finish
Cobra Flex Chain Louvre	<b>G473</b>	Min. <b>0054</b>	<b>90</b>	<b>27</b> 2700K	1.5W/LED	183lm/LED	<b>10 / 17 / 29 / EL / WW</b>	<b>00</b> No Driver	<b>10</b> ■ Black
		⋮		<b>30</b> 3000K					<b>11</b> □ White
		Max. <b>1014</b>		<b>35</b> 3500K					<b>28</b> ■ Brass Polished
				<b>40</b> 4000K					<b>35</b> ■ Gold
				<b>75</b> 2100K					
				<b>24</b> 2400K					

**Notes:**

<sup>1</sup> Information in the chart above is related to 3000K LED.



# Driver Options

## Constant Current

### Cobra Flex Chain Louvre



L Art. 2C02D0 (On/Off)  
 N Art. 2C02D1 (0-10V)  
 Dim Art. 2C02DA (DALI)

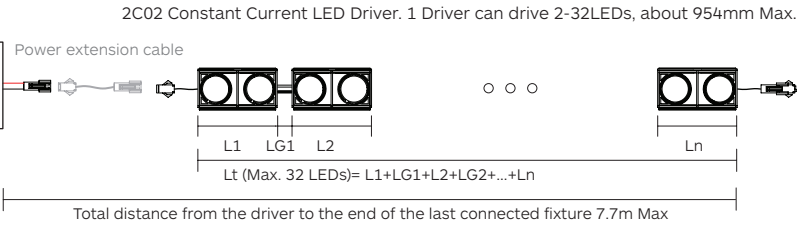

### G473

Power extension cable. Art. **2C47**. 1m (if necessary).

Vin= 180-277V AC 50/60Hz  
 Iout= 1050mA V=2-57V  
 P= 60W Max.  
 Dimensions: 123.5x81.5x23mm  
 IP20

# Cobra Flex Louvre

Designed by Ponctuelle



## Body

Surface mounted modular system in extruded aluminium.  
Available in different length configurations based on a 54mm link (2 LED per link) with a 60mm increment.  
Section 28.5x30mm.  
Its flexible structure maintain a constant 30mm pitch between the LED.  
Integrated louvre.

Mounting options:  
U mounting clips.

**\* Plastic free packaging.**

## Accessories

Mounting accessories included.  
Power extension cable Art. 2C47 to be ordered separately.

## Finish

Anodized black, white, brass polished or gold finish.  
Other finish options available on request.

## LED sources

Power LED.  
CRI: 75 & 90 | R9: >50 | CCT: 2100K, 2400K, 2700K, 3000K, 3500K, 4000K.  
3-Step MacAdam.  
Other CRI and CCT options available on request.

## Optic

Lens.  
Beam angle: 10° / 17° / 29° / elliptical (15° x 50°).  
Wallwasher optics.

## Driver

Driver not included to be ordered separately.  
Work with 1050 mA Constant Current Driver positioned remotely.

## Applications

Ideal for indirect cove illumination, it creates a wall grazing effect for columns and curved architectonic surfaces. Its flexible structure maintain a constant pitch between LED, insuring a continuous illumination without any shadows or dark areas. Application areas: Cove light, wallwash, residential, hospitality, restaurants, museums.

## Related Products

**Cobra Linealuce** 

**Cobra Flex** 

**Cobra Flex Chain** 

**Cobra Linealuce Louvre** 

**Cobra Flex Chain Louvre** 

**Cobra Pro IP66** 



# Cobra Flex Louvre | G437

**Cobra**  
Flex Louvre



**Min. L= 54mm (2 x LED) 1 Link**

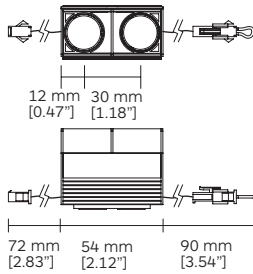

**Mounting options**

With mounting U clip

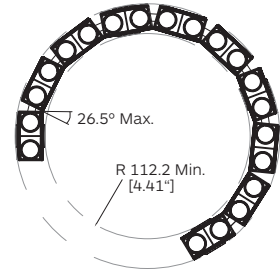
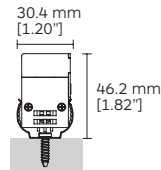

**Max. L= 954mm (32 x LED) 16 Links**

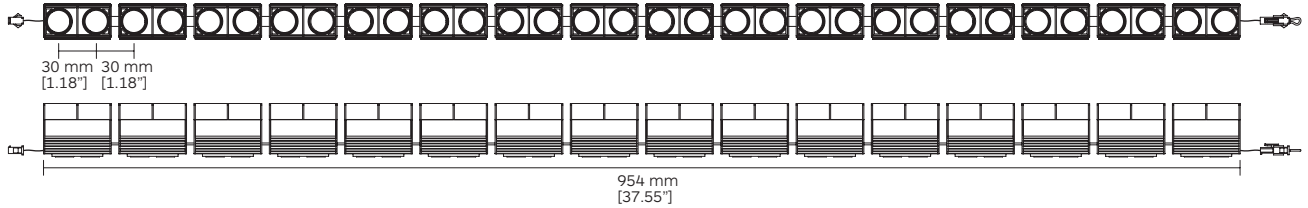

**Available length codes <sup>1</sup>**

No. of Links	Voltage	LED Power	Length code	Length in mm	Length in inches	Nominal Lumen	No. of Links	Voltage	LED Power	Length code	Length in mm	Length in inches	Nominal Lumen
1	3.3V	3.1W	<b>0054</b>	54	2.12	366 lm	9	29.7V	28.3W	<b>0534</b>	534	21.02	3294 lm
2	6.6V	6.3W	<b>0114</b>	114	4.48	732 lm	10	33V	31.5W	<b>0594</b>	594	23.38	3660 lm
3	9.9V	9.4W	<b>0174</b>	174	6.85	1098 lm	11	36.3V	34.6W	<b>0654</b>	654	25.74	4026 lm
4	13.2V	12.6W	<b>0234</b>	234	9.21	1464 lm	12	39.6V	37.8W	<b>0714</b>	714	28.11	4392 lm
5	16.5V	15.7W	<b>0294</b>	294	11.57	1830 lm	13	42.9V	40.9W	<b>0774</b>	774	30.47	4758 lm
6	19.8V	18.9W	<b>0354</b>	354	13.93	2196 lm	14	46.2V	44.1W	<b>0834</b>	834	32.83	5124 lm
7	23.1V	22W	<b>0414</b>	414	16.29	2562 lm	15	49.5V	47.2W	<b>0894</b>	894	35.19	5490 lm
8	26.4V	25.2W	<b>0474</b>	474	18.66	2928 lm	16	52.8V	50.4W	<b>0954</b>	954	37.55	5856 lm

Code ordering example: **G 4 3 7 0 0 5 4 - 9 0 2 7 1 0 0 0 1 0**

	Product code*	Length code	>CRI	CCT**	LED Power	Nominal Lumen	Beam angle (BA°)	Driver Options	Finish
Cobra Flex Louvre	<b>G437</b>	Min. <b>0054</b>	<b>90</b>	<b>27</b> 2700K	1.5W/LED	183lm/LED	<b>10 / 17 / 29 / EL / WW</b>	<b>00</b> No Driver	<b>10</b> ■ Black
		⋮		<b>30</b> 3000K					<b>11</b> □ White
		Max. <b>0954</b>		<b>35</b> 3500K					<b>28</b> ■ Brass Polished
				<b>40</b> 4000K					<b>35</b> ■ Gold
			<b>75</b>	<b>21</b> 2100K		173lm/LED			
				<b>24</b> 2400K					

**Notes:**

<sup>1</sup> Information in the chart above is related to 3000K LED.

# Driver Options

## Constant Current

### Cobra Flex Louvre

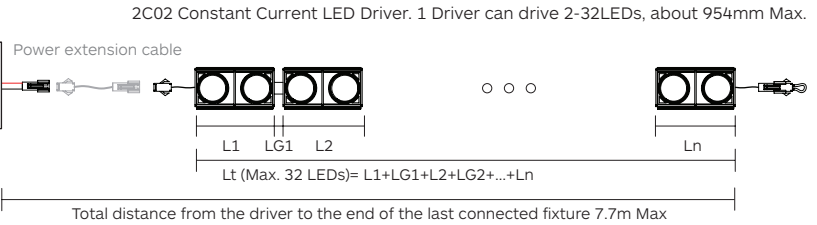
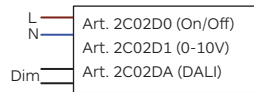

### G437

Power extension cable. Art. **2C47**. 1m (if necessary).

Vin= 180-277V AC 50/60Hz  
 Iout= 1050mA V=2-57V  
 P= 60W Max.  
 Dimensions: 123.5x81.5x23mm  
 IP20

# Cobra Infinito

Designed by Ponctuelle



## Body

Surface-mounted LED system in extruded aluminum. Available in different length configurations starting from 120mm with an increment of 120mm.

Section 28.5x30mm. Constant 30mm pitch between the LED.

Mounting options:  
U mounting clips.

**Plastic free packaging.**

## Accessories

Mounting accessories included.  
Honeycomb Art. 2F76, Louvre Art 2F74 to be ordered separately.  
Power extension cable Art. 2E46 to be ordered separately.

## Finish

Anodized black, white, brass polished, or gold finish. Other finish options are available on request.

## LED sources

Power LED. CRI: 90 | R9: >50  
CCT: 2700K, 3000K, 3500K, 4000K.  
3-Step MacAdam.  
Other CRI and CCT options are available on request.

## Optic

Lens.  
Beam angle: 10° / 17° / 29° / elliptical (15° x 50°).  
Wallwasher optics.

## Driver

Each Cobra fixture comes with dimmable integrated 48V DCDC driver. Works with integrated power supply positioned remotely.  
Power Supply not included, to be ordered separately.

## Applications

Ideal for indirect cove illumination, it creates a wall grazing effect for columns and architectonic surfaces. Its flexible structure maintains a constant pitch between LED, ensuring continuous illumination without any shadows or dark areas. Application areas: Cove light, wallwash, residential, hospitality, restaurants, and museums.

### Related Products

**Cobra  
Infinito Flex** 

**Cobra  
Linealuce** 

**Cobra  
Flex** 

**Cobra Flex  
Chain** 

# Cobra Infinito | G486

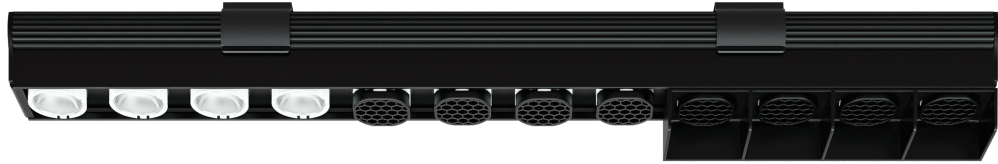

Cobra Infinito

**Min. L= 120mm (4 x LED)**

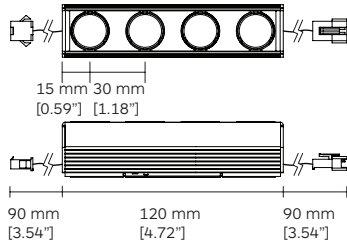

**Mounting options**

With mounting U clip

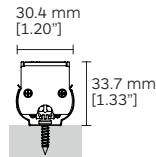

**Accessories**

Honeycomb Art. 2F76

Louvre Art 2F74

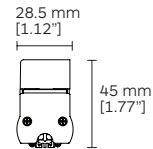
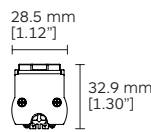

**Max. L= 1080mm (36 x LED)**

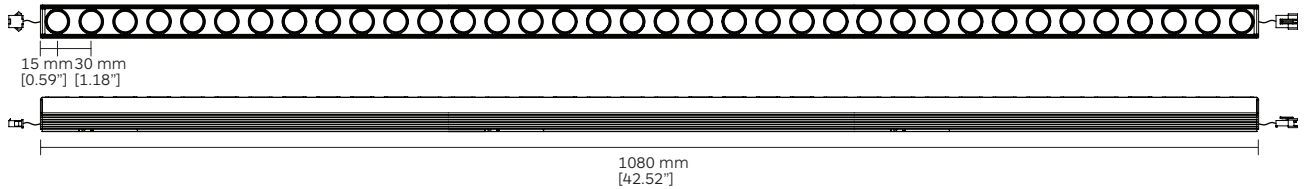

**Available length codes <sup>1</sup>**

No. of LEDs	LED Power	Length code	Length in mm	Length in inches	Nominal Lumen	No. of LEDs	LED Power	Length code	Length in mm	Length in inches	Nominal Lumen
4	5.8W	<b>0120</b>	120	4.72	708 lm	24	34.8W	<b>0720</b>	720	28.34	4248 lm
8	11.6W	<b>0240</b>	240	9.44	1416 lm	28	40.6W	<b>0840</b>	840	33.04	4956 lm
12	17.4W	<b>0360</b>	360	14.17	2124 lm	32	46.4W	<b>0960</b>	960	37.79	5664 lm
16	23.2W	<b>0480</b>	480	18.89	2832 lm	36	52.2W	<b>1080</b>	1080	42.52	6372 lm
20	29W	<b>0600</b>	600	23.62	3540 lm						

Code ordering example: **G 4 8 6 0 1 2 0 . 9 0 2 7 1 0 4 D 1 0**

	Product code*	Length code	>CRI	CCT**	LED Power	Nominal Lumen	Beam angle (BA°)	Driver Options	Finish
Cobra Infinito	<b>G486</b>	Min. <b>0120</b>	<b>90</b>	<b>27</b> 2700K	1.45W/LED	177lm/LED	<b>10 / 17 / 29 / EL / WW</b>	<b>4D</b> 48VDC dimmable	<b>10</b> ■ Black
Min & Max. Length		⋮		<b>30</b> 3000K					<b>11</b> □ White
		Max. <b>1080</b>		<b>35</b> 3500K					<b>28</b> ■ Brass Polished
				<b>40</b> 4000K					<b>35</b> ■ Gold

**Notes:**

<sup>1</sup> Information in the chart above is related to 3000K LED.

# Driver Options

## Constant Voltage

Cobra Infinito

2V48 Constant Voltage Driver. 1 Driver have 2 outlets, 1 outlet can drive 4-64LEDs, about 1920mm Max.

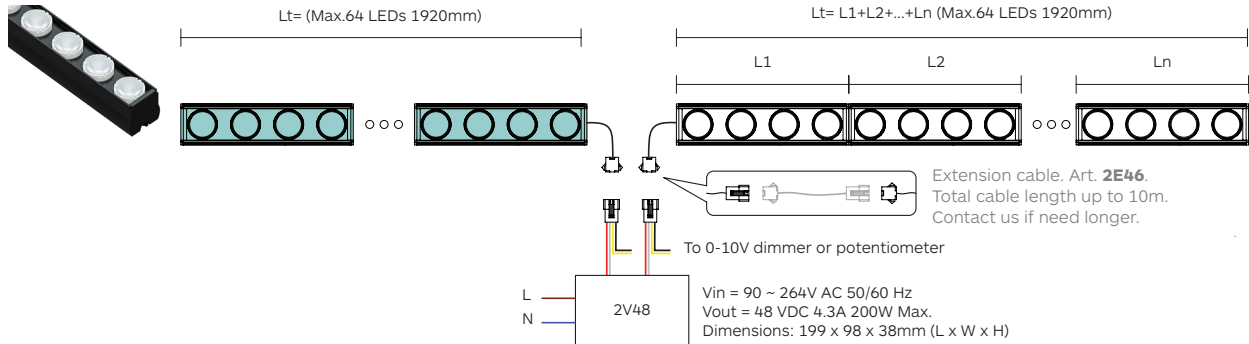

G486

# Accessories

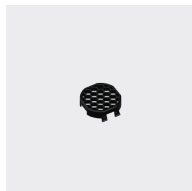

Honeycomb



Louvre

Product / Accessories

Colour 10

Colour 10

Cobra Infinito

**2F76**

**2F74**

\* Please refer to the user manuals for further details.

# Cobra Infinito Flex

Designed by Ponctuelle

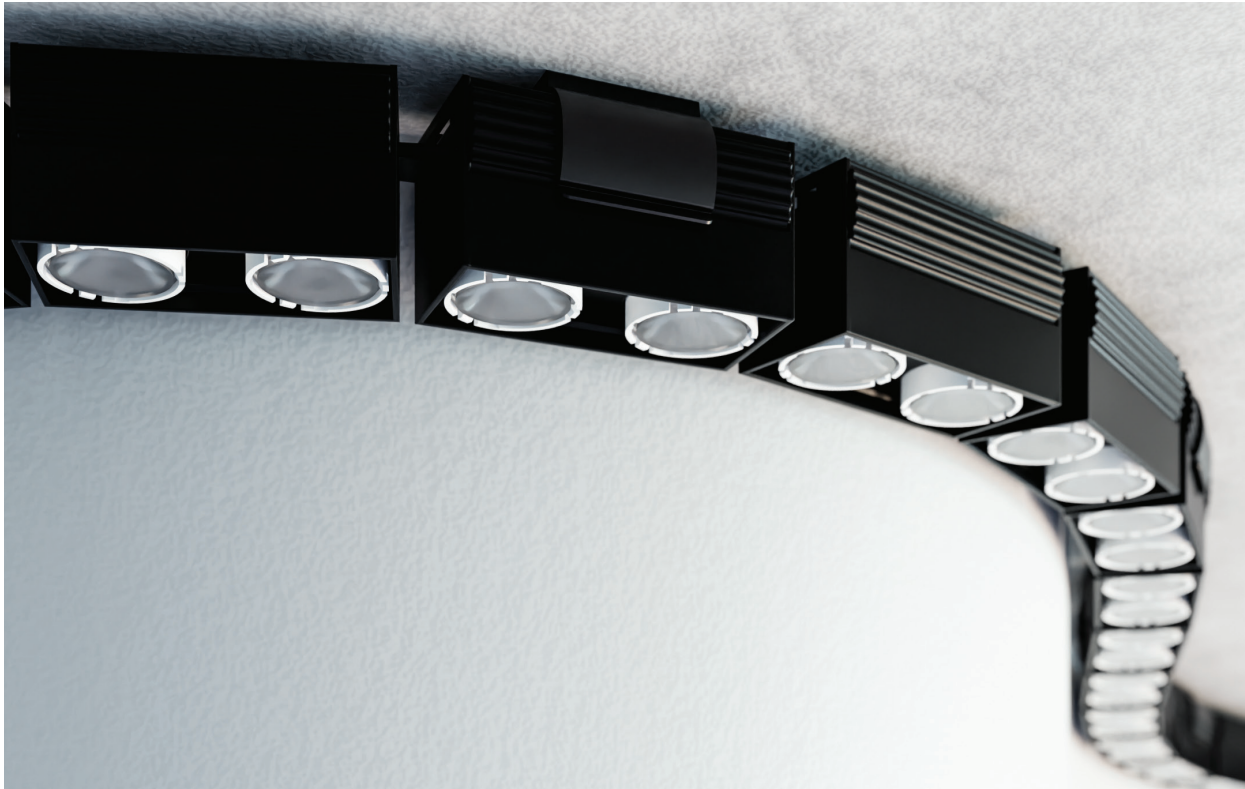

## Body

Surface-mounted modular system in extruded aluminum. Available in different length configurations based on a 54mm link (2 LED per link) with a 60mm increment. Section 28.5x30mm. Its flexible structure maintains a constant 30mm pitch between the LED.

Mounting options:  
U mounting clips.

**Plastic free packaging.**

## Accessories

Mounting accessories included.  
Honeycomb Art. 2F76, Louvre Art 2F75 to be ordered separately.  
Power extension cable Art. 2E46 to be ordered separately.

## Finish

Anodized black, white, brass polished, or gold finish. Other finish options are available on request.

## LED sources

Power LED. CRI: 90 | R9: >50  
CCT: 2700K, 3000K, 3500K, 4000K.  
3-Step MacAdam.  
Other CRI and CCT options are available on request.

## Optic

Lens.  
Beam angle: 10° / 17° / 29° / elliptical (15° x 50°).  
Wallwasher optics.

## Driver

Each Cobra Flex fixture comes with dimmable integrated 48V DCDC driver. Works with integrated power supply positioned remotely.  
Power Supply not included, to be ordered separately.

## Applications

Ideal for indirect cove illumination, it creates a wall grazing effect for columns and curved architectonic surfaces. Its flexible structure maintains a constant pitch between LED, ensuring continuous illumination without any shadows or dark areas. Application areas: Cove light, wallwash, residential, hospitality, restaurants, and museums.

### Related Products

**Cobra Flex**



**Cobra Linealuce**



**Cobra Flex Chain**



**Cobra Infinito**





# Cobra Infinito Flex | G484

**Cobra Infinito**  
Flex



**Min. L= 54mm (2 x LED) 1 Link**

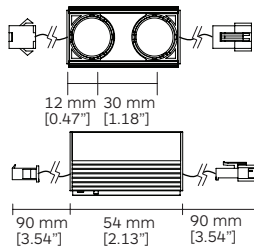

**Mounting options**

With mounting U clip

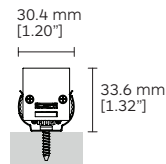

**Accessories**

Honeycomb Art. 2F76

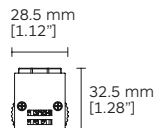

Louvre Art. 2F75

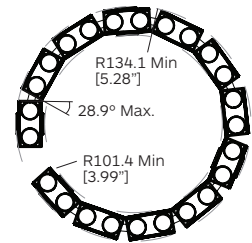
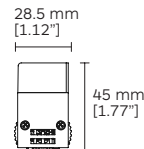

**Max. L= 1074mm (36 x LED) 18 Links Max.**

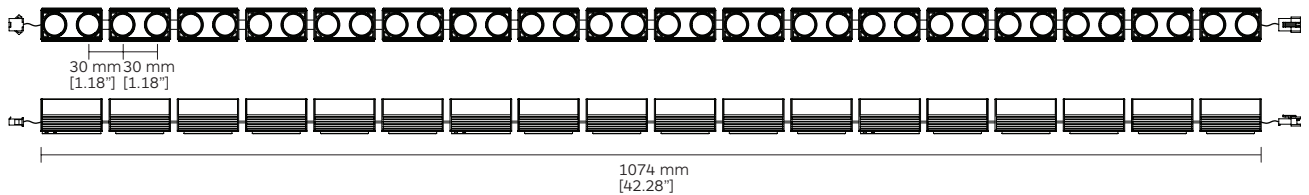

**Available length codes <sup>1</sup>**

No. of Links	LED Power	Length code	Length in mm	Length in inches	Nominal Lumen	No. of Links	LED Power	Length code	Length in mm	Length in inches	Nominal Lumen
1	2.9W	<b>0054</b>	54	2.12	354 lm	10	29W	<b>0594</b>	594	23.38	3540 lm
2	5.8W	<b>0114</b>	114	4.48	708 lm	11	31.9W	<b>0654</b>	654	25.74	3894 lm
3	8.7W	<b>0174</b>	174	6.85	1062 lm	12	34.8W	<b>0714</b>	714	28.11	4248 lm
4	11.6W	<b>0234</b>	234	9.21	1416 lm	13	37.7W	<b>0774</b>	774	30.47	4602 lm
5	14.5W	<b>0294</b>	294	11.57	1770 lm	14	40.6W	<b>0834</b>	834	32.83	4956 lm
6	17.4W	<b>0354</b>	354	13.93	2124 lm	15	43.5W	<b>0894</b>	894	35.19	5310 lm
7	20.3W	<b>0414</b>	414	16.29	2478 lm	16	46.4W	<b>0954</b>	954	37.55	5664 lm
8	23.2W	<b>0474</b>	474	18.66	2832 lm	17	49.3W	<b>1014</b>	1014	39.92	6018 lm
9	26.1W	<b>0534</b>	534	21.02	3186 lm	18	52.2W	<b>1074</b>	1074	42.28	6372 lm

Code ordering example: **G 4 8 4 0 0 5 4 . 9 0 2 7 1 0 4 D 1 0**

	Product code*	Length code	>CRI	CCT**	LED Power	Nominal Lumen	Beam angle (BA°)	Driver Options	Finish
Cobra Infinito Flex Min & Max. Length	<b>G484</b>	Min. <b>0054</b>	<b>90</b>	<b>27</b> 2700K	1.45W/LED	177lm/LED	<b>10 / 17 / 29 / EL / WW</b>	<b>4D</b> 48VDC dimmable	<b>10</b> ■ Black
		⋮	<b>30</b> 3000K	<b>11</b> □ White					
		Max. <b>1074</b>	<b>35</b> 3500K	<b>28</b> ■ Brass Polished					
			<b>40</b> 4000K	<b>35</b> ■ Gold					

**Notes:**

<sup>1</sup> Information in the chart above is related to 3000K LED.

# Driver Options

## Constant Voltage

**Cobra Infito Flex**

2V48 Constant Voltage Driver. 1 Driver have 2 outlets, 1 outlet can drive 2-64LEDs, about 1920mm Max.

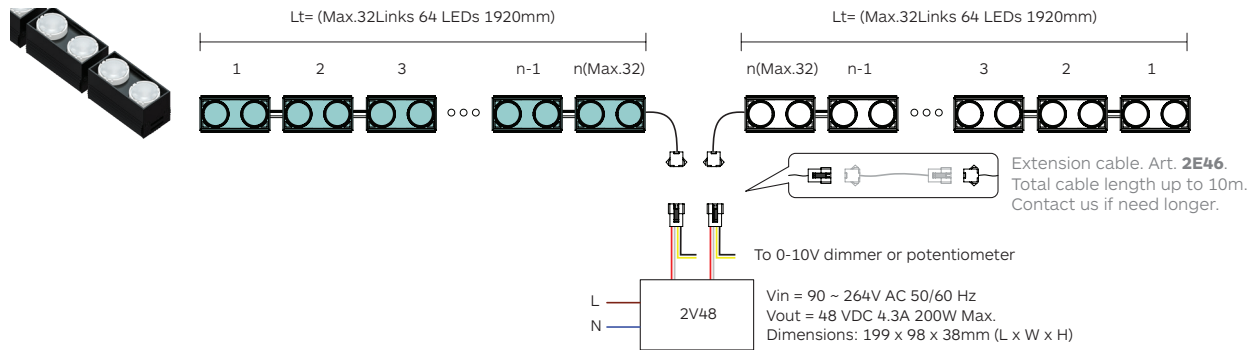

**G484**

# Accessories

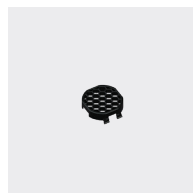

Honeycomb



Louvre

Product / Accessories

Colour 10

Colour 10

Cobra Infito Flex

**2F76**

**2F75**

\* Please refer to the user manuals for further details.

# Cobra Linealuce

Designed by Ponctuelle

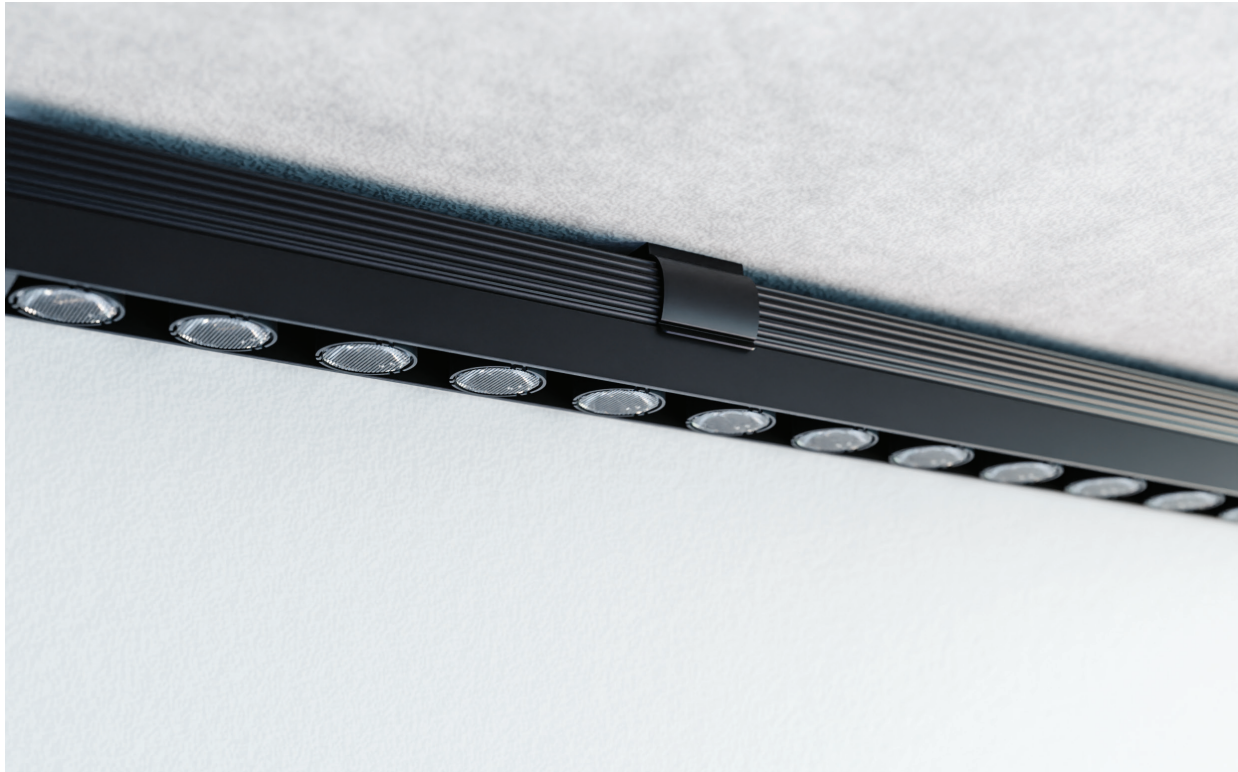

## Body

Surface mounted LED system in extruded aluminium.  
Available in different length configurations starting from 120mm with increment of 120mm.  
Section 28.5x30mm.  
Constant 30mm pitch between the LED.

Mounting options:  
U mounting clips.

**\* Plastic free packaging.**

## Accessories

Honeycomb Art. 2D88.  
Color filter Art. 2E40.  
Mounting accessories included.  
Power extension cable Art. 2C47 to be ordered separately.

## Finish

Anodized black, white, brass polished or gold finish.  
Other finish options available on request.

## LED sources

Power LED.  
CRI: 75 & 90 | R9: >90 | CCT: 2100K, 2400K, 2700K, 3000K, 3500K, 4000K.  
3-Step MacAdam.  
Other CRI and CCT options available on request.

## Optic

Lens.  
Beam angle: 10° / 17° / 29° / elliptical (15° x 50°).  
Wallwasher optics.

## Driver

Driver not included to be ordered separately.  
Work with 1050 mA Constant Current Driver positioned remotely.

## Applications

Ideal for indirect cove illumination, it creates a wall grazing effect for columns and curved architectural surfaces.  
The constant pitch between its LED, insures a continuous illumination without any shadows or dark areas.  
Application areas: Cove light, wallwash, residential, hospitality, restaurants, museums.

## Related Products

**Cobra Flex** 

**Cobra Flex Chain** 

**Cobra Linealuce Louvre** 

**Cobra Flex Louvre** 

**Cobra Flex Chain Louvre** 

**Cobra Pro IP66** 



# Cobra Linealuce | G449

**Cobra**  
Linealuce



## Min. L= 120mm (4 x LED)

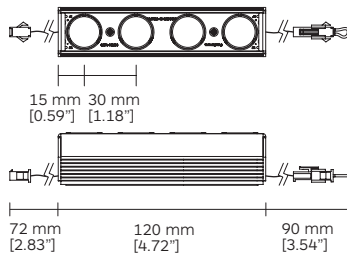

## Mounting options

With mounting U clip

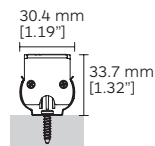

## Accessories

Honeycomb Art. 2D88

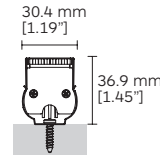

## Max. L= 960 mm (32 x LED)

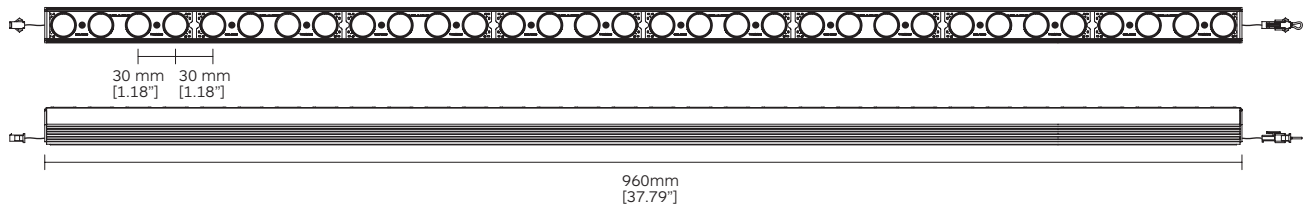

## Available length codes <sup>1</sup>

No. of LEDs	Voltage	LED Power	Length code	Length in mm	Length in inches	Nominal Lumen	No. of LEDs	Voltage	LED Power	Length code	Length in mm	Length in inches	Nominal Lumen
4	6.6V	6.3W	<b>0120</b>	120	4.72	732 lm	20	33V	31.5W	<b>0600</b>	600	23.62	3660 lm
8	13.2V	12.6W	<b>0240</b>	240	9.44	1464 lm	24	39.6V	37.8W	<b>0720</b>	720	28.34	4392 lm
12	19.8V	18.9W	<b>0360</b>	360	14.17	2196 lm	28	46.2V	44.1W	<b>0840</b>	840	33.04	5124 lm
16	26.4V	25.2W	<b>0480</b>	480	18.89	2928 lm	32	52.8V	50.4W	<b>0960</b>	960	37.79	5856 lm

Code ordering example: **G 4 4 9 0 1 2 0 - 9 0 2 7 1 0 0 0 1 0**

	Product code*	Length code	>CRI	CCT**	LED Power	Nominal Lumen	Beam angle (BA°)	Driver Options	Finish
Cobra Linealuce	<b>G449</b>	Min. <b>0120</b>	<b>90</b>	<b>27</b> 2700K	1.5W/LED	183lm/LED	<b>10 / 17 / 29 / EL / WW</b>	<b>00</b> No Driver	<b>10</b> ■ Black
		⋮		<b>30</b> 3000K					<b>11</b> □ White
		Max. <b>0960</b>		<b>35</b> 3500K					<b>28</b> ■ Brass Polished
				<b>40</b> 4000K					<b>35</b> ■ Gold
			<b>75</b>	<b>21</b> 2100K		173lm/LED			
				<b>24</b> 2400K					

## Notes:

<sup>1</sup> Information in the chart above is related to 3000K LED.

# Driver Options

## Constant Current

### Cobra Linealuce

2C02 Constant Current LED Driver. 1 Driver can drive 4-32LEDs, about 960mm Max.

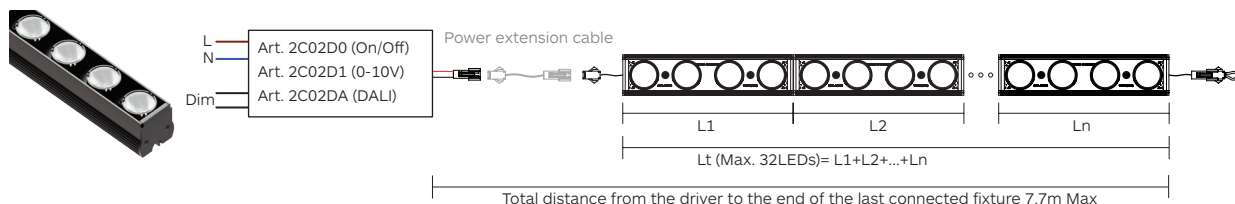

**G449**

Power extension cable. Art. **2C47**. 1m (if necessary).

Vin= 180-277V AC 50/60Hz  
Iout= 1050mA V=2-57V  
P= 60W Max.  
Dimensions: 123.5x81.5x23mm  
IP20

# Accessories

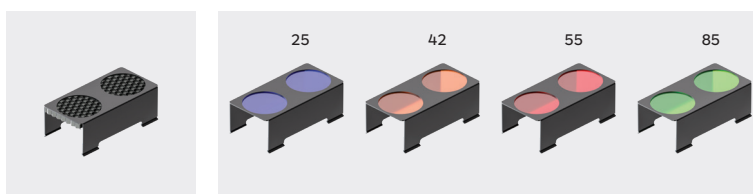

Product / Accessories

Honeycomb

Coloured  
Filters

Finish: 10

Filter colour codes: 25 / 42 / 55 / 85

Cobra Linealuce

**2D88**

**2E40-25**  
**2E40-42**  
**2E40-55**  
**2E40-85**

\* Please refer to the user manuals for further details.

# Cobra Linealuze Louvre

Designed by Ponctuelle



## Body

Surface mounted LED system in extruded aluminium.  
Available in different length configurations starting from 120mm with increment of 120mm.  
Section 28.5x30mm.  
Constant 30mm pitch between the LED.  
Integrated louvre.

Mounting options:  
U mounting clips.

**\* Plastic free packaging.**

## Accessories

Mounting accessories included.  
Power extension cable Art. 2C47 to be ordered separately.

## Finish

Anodized black, white, brass polished or gold finish.  
Other finish options available on request.

## LED sources

Power LED.  
CRI: 75 & 90 | R9: >50 | CCT: 2100K, 2400K, 2700K, 3000K, 3500K, 4000K.  
3-Step MacAdam.  
Other CRI and CCT options available on request.

## Optic

Lens.  
Beam angle: 10° / 17° / 29° / elliptical (15° x 50°).  
Wallwasher optics.

## Driver

Driver not included to be ordered separately.  
Work with 1050 mA Constant Current Driver positioned remotely.

## Applications

Ideal for indirect cove illumination, it creates a wall grazing effect for columns and curved architectonic surfaces.  
The constant pitch between its LED, insures a continuous illumination without any shadows or dark areas.  
Application areas: Cove light, wall grazing, residential, hospitality, restaurants, museums.

## Related Products

**Cobra Linealuze** 

**Cobra Flex** 

**Cobra Flex Chain** 

**Cobra Flex Louvre** 

**Cobra Flex Chain Louvre** 

**Cobra Pro IP66** 



# Cobra Linealuce Louvre | G450

**Cobra**  
Linealuce  
Louvre



## Min. L= 120mm (4 x LED)

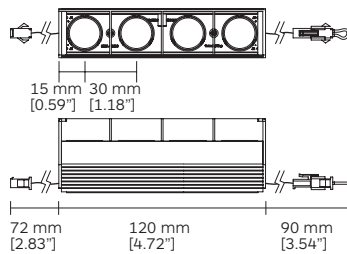

## Mounting options

With mounting U clip

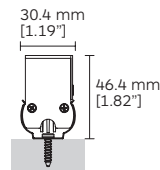

## Max. L= 960 mm (32 x LED)

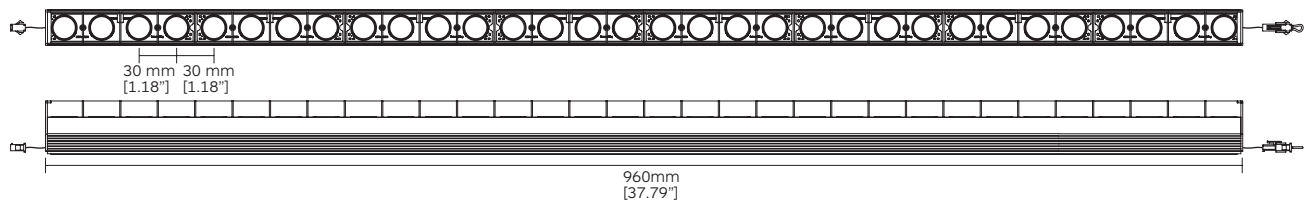

## Available length codes <sup>1</sup>

No. of LEDs	Voltage	LED Power	Length code	Length in mm	Length in inches	Nominal Lumen	No. of LEDs	Voltage	LED Power	Length code	Length in mm	Length in inches	Nominal Lumen
4	6.6V	6.3W	<b>0120</b>	120	4.72	732 lm	20	33V	31.5W	<b>0600</b>	600	23.62	3660 lm
8	13.2V	12.6W	<b>0240</b>	240	9.44	1464 lm	24	39.6V	37.8W	<b>0720</b>	720	28.34	4392 lm
12	19.8V	18.9W	<b>0360</b>	360	14.17	2196 lm	28	46.2V	44.1W	<b>0840</b>	840	33.04	5124 lm
16	26.4V	25.2W	<b>0480</b>	480	18.89	2928 lm	32	52.8V	50.4W	<b>0960</b>	960	37.79	5856 lm

Code ordering example: **G 4 5 0 0 1 2 0 - 9 0 2 7 1 0 0 0 1 0**

	Product code*	Length code	>CRI	CCT**	LED Power	Nominal Lumen	Beam angle (BA°)	Driver Options	Finish
Cobra Linealuce Louvre	<b>G450</b>	Min. <b>0120</b>	<b>90</b>	<b>27</b> 2700K	1.5W/LED	183lm/LED	<b>10 / 17 / 29 / EL / WW</b>	<b>00</b> No Driver	<b>10</b> ■ Black
		⋮		<b>30</b> 3000K					<b>11</b> □ White
		Max. <b>0960</b>		<b>35</b> 3500K					<b>28</b> ■ Brass Polished
				<b>40</b> 4000K					<b>35</b> ■ Gold
				<b>75</b> <b>21</b> 2100K					
				<b>24</b> 2400K					

## Notes:

<sup>1</sup> Information in the chart above is related to 3000K LED.

# Driver Options

## Constant Current

### Cobra Linealuce Louvre

2C02 Constant Current LED Driver. 1 Driver can drive 4-32LEDs, about 960mm Max.

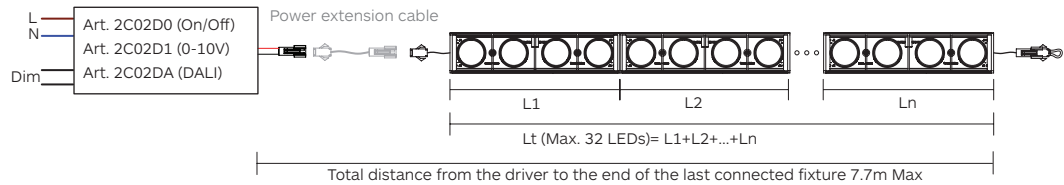

### G450

Power extension cable. Art. **2C47**. 1m (if necessary).

Vin= 180-277V AC 50/60Hz  
Iout= 1050mA V=2-57V  
P= 60W Max.  
Dimensions: 123.5x81.5x23mm  
IP20



# Mini Cobra Flex

Designed by Ponctuelle



## Body

Surface mounted modular system in extruded aluminium.  
Available in different length configurations based on a 56mm link (2 LED per link) with a 60mm increment.  
Section 14x13mm.  
Its flexible structure maintain a constant 30mm pitch between the LED.

Mounting options:  
Integrated magnets for easy installation.  
L mounting brackets.  
U mounting clips.

**\* Plastic free packaging.**

## Accessories

Honeycomb Art. 2D97.  
Color filter Art. 2E41.  
Mounting accessories included.  
Power extension cable Art. 2C47 to be ordered separately.

## Finish

Anodized black, white, brass polished or gold finish.  
Other finish options available on request.

## LED sources

Power LED.  
CRI: 75 & 97 | R9: >90 | CCT: 2100K, 2400K, 2700K, 3000K, 3500K, 4000K.  
3-Step MacAdam.  
Other CRI and CCT options available on request.

## Optic

Lens.  
Beam angle: 21° / 29° / elliptical (22° x 47°).

## Driver

Driver not included to be ordered separately.  
Work with 700 mA Constant Current Driver positioned remotely.

## Applications

Ideal for indirect cove illumination, it creates a wall grazing effect for columns and curved architectural surfaces. It is also a great pick also for display showcase illumination.  
Application areas: Cove light, wallwash, residential, hospitality, restaurants, museums, display showcases.

## Related Products

**Mini Cobra Linealuce** 

**Mini Cobra Linealuce Louvre** 

**Mini Cobra Flex Louvre** 

**Mini Cobra Pro** 

**Mini Cobra Pro Louvre** 

# Mini Cobra Flex | G430

**Mini Cobra**  
Flex

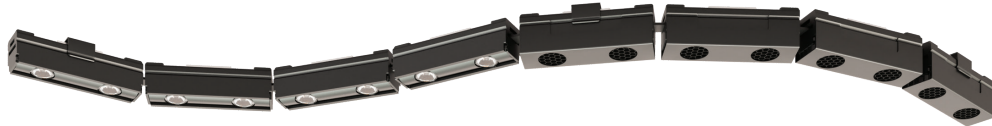

## Min. L= 56mm (2 x LED) 1 Link

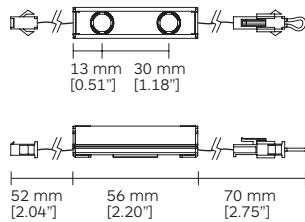

## Mounting options

With magnet L bracket    With mounting U clip    With magnet



## Accessories

Honeycomb Art. 2D97

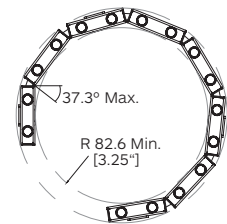

## Max. L= 956mm (32 x LED) 16 Links

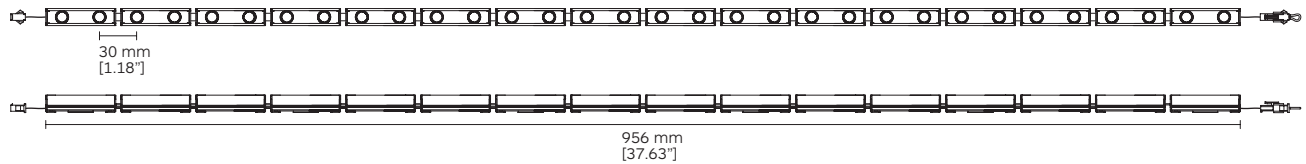

## Available length codes <sup>1</sup>

No. of Links	Voltage	LED Power	Length code	Length in mm	Length in inches	Nominal Lumen	No. of Links	Voltage	LED Power	Length code	Length in mm	Length in inches	Nominal Lumen
1	3.2V	2W	<b>0056</b>	56	2.20	180 lm	9	28.8V	18W	<b>0536</b>	536	21.10	1620 lm
2	6.4V	4W	<b>0116</b>	116	4.56	360 lm	10	32V	20W	<b>0596</b>	596	23.46	1800 lm
3	9.6V	6W	<b>0176</b>	176	6.92	540 lm	11	35.2V	22W	<b>0656</b>	656	25.82	1980 lm
4	12.8V	8W	<b>0236</b>	236	9.29	720 lm	12	38.4V	24W	<b>0716</b>	716	28.18	2160 lm
5	16V	10W	<b>0296</b>	296	11.65	900 lm	13	41.6V	26W	<b>0776</b>	776	30.55	2340 lm
6	19.2V	12W	<b>0356</b>	356	14.01	1080 lm	14	44.8V	28W	<b>0836</b>	836	32.91	2520 lm
7	22.4V	14W	<b>0416</b>	416	16.37	1260 lm	15	48V	30W	<b>0896</b>	896	35.27	2700 lm
8	25.6V	16W	<b>0476</b>	476	18.74	1440 lm	16	51.2V	32W	<b>0956</b>	956	37.63	2880 lm

Code ordering example: **G 4 3 0 0 0 5 6 - 9 7 2 7 2 1 0 0 1 0**

	Product code*	Length code	>CRI	CCT**	LED Power	Nominal Lumen	Beam angle (BA°)	Driver Options	Finish
Mini Cobra Flex	<b>G430</b>	Min. <b>0056</b>	<b>97</b>	<b>27</b> 2700K	1W/LED	90 lm/LED	<b>21 / 29 / EL</b>	<b>00</b> No Driver	<b>10</b> ■ Black
		⋮		<b>30</b> 3000K					<b>11</b> □ White
		Max. <b>0956</b>		<b>35</b> 3500K					<b>28</b> ■ Brass Polished
				<b>40</b> 4000K					<b>35</b> ■ Gold
			<b>75</b>	<b>21</b> 2100K		121 lm/LED			
				<b>24</b> 2400K					

### Notes:

<sup>1</sup> Information in the chart above is related to 3000K LED.

# Driver Options

## Constant Current

### Mini Cobra Flex

2C07 Constant Current LED Driver. 1 Driver can drive 2-32 LEDs, about 956mm Max.

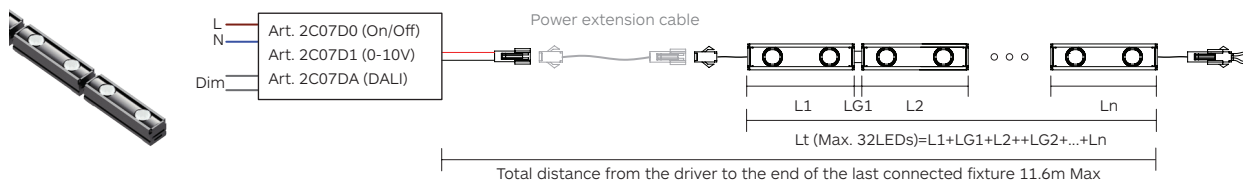

### G430

Power extension cable. Art. **2C47**. 1m (if necessary).

Vin= 180~277V AC 50/60Hz  
Iout= 700mA V=2~57V  
P= 40W Max.  
Dimensions: 123.5x81.5x23mm  
IP20

# Accessories

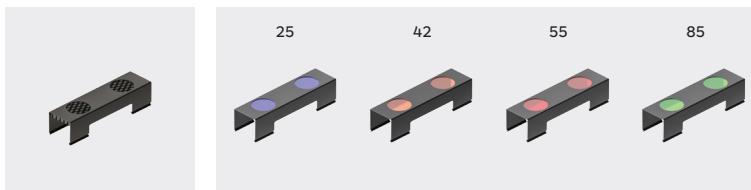

Product / Accessories

Honeycomb

Coloured Filters

Finish: 10

Filter colour codes: 25 / 42 / 55 / 85

Mini Cobra Flex

**2D97**

**2E41-25**  
**2E41-42**  
**2E41-55**  
**2E41-85**

\* Please refer to the user manuals for further details.

# Mini Cobra Flex Louvre

Designed by Ponctuelle



## Body

Surface mounted modular system in extruded aluminium.  
Available in different length configurations based on a 56mm link (2 LED per link) with a 60mm increment.  
Section 15x27mm.  
Its flexible structure maintain a constant 30mm pitch between the LED.  
Integrated louvre.

Mounting options:  
Integrated magnets for easy installation.  
L mounting brackets.  
U mounting clips.

**\* Plastic free packaging.**

## Accessories

Mounting accessories included.  
Power extension cable Art. 2C47 to be ordered separately.

## Finish

Anodized black, white, brass polished or gold finish.  
Other finish options available on request.

## LED sources

Power LED.  
CRI: 75 & 97 | R9: >90 | CCT: 2100K, 2400K, 2700K, 3000K, 3500K, 4000K.  
3-Step MacAdam.  
Other CRI and CCT options available on request.

## Optic

Lens.  
Beam angle: 21° / 29° / elliptical (22° x 47°).

## Driver

Driver not included to be ordered separately.  
Work with 700 mA Constant Current Driver positioned remotely.

## Applications

Ideal for indirect cove illumination, it creates a wall grazing effect for columns and curved architectural surfaces. It is also a great pick also for display showcase illumination.  
Application areas: Cove light, wall grainger, residential, hospitality, restaurants, museums, display showcases.

## Related Products

**Mini Cobra Linealuce** 

**Mini Cobra Flex** 

**Mini Cobra Linealuce Louvre** 

**Mini Cobra Pro** 

**Mini Cobra Pro Louvre** 

# Mini Cobra Flex Louvre | G439

Mini Cobra  
Flex Louvre



Min. L= 56mm (2 x LED) 1 Link

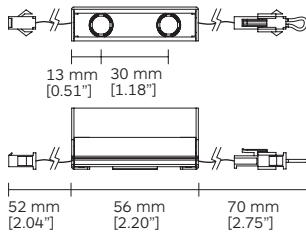

Mounting options

With magnet L bracket

With mounting U clip

With magnet

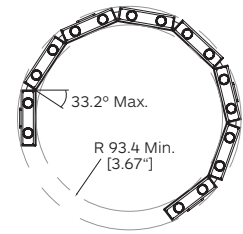
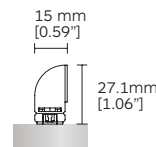
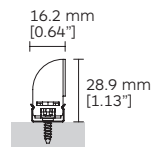
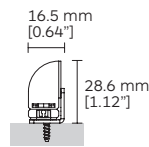

Max. L= 956mm (32 x LED) 16 Links

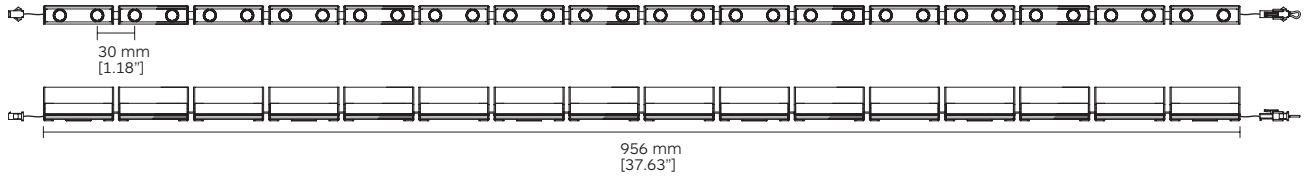

Available length codes <sup>1</sup>

No. of Links	Voltage	LED Power	Length code	Length in mm	Length in inches	Nominal Lumen	No. of Links	Voltage	LED Power	Length code	Length in mm	Length in inches	Nominal Lumen
1	3.2V	2W	<b>0056</b>	56	2.20	180 lm	9	28.8V	18W	<b>0536</b>	536	21.10	1620 lm
2	6.4V	4W	<b>0116</b>	116	4.56	360 lm	10	32V	20W	<b>0596</b>	596	23.46	1800 lm
3	9.6V	6W	<b>0176</b>	176	6.92	540 lm	11	35.2V	22W	<b>0656</b>	656	25.82	1980 lm
4	12.8V	8W	<b>0236</b>	236	9.29	720 lm	12	38.4V	24W	<b>0716</b>	716	28.18	2160 lm
5	16V	10W	<b>0296</b>	296	11.65	900 lm	13	41.6V	26W	<b>0776</b>	776	30.55	2340 lm
6	19.2V	12W	<b>0356</b>	356	14.01	1080 lm	14	44.8V	28W	<b>0836</b>	836	32.91	2520 lm
7	22.4V	14W	<b>0416</b>	416	16.37	1260 lm	15	48V	30W	<b>0896</b>	896	35.27	2700 lm
8	25.6V	16W	<b>0476</b>	476	18.74	1440 lm	16	51.2V	32W	<b>0956</b>	956	37.63	2880 lm

Code ordering example: **G 4 3 9 0 0 5 6 - 9 7 2 7 2 1 0 0 1 0**

	Product code*	Length code	>CRI	CCT**	LED Power	Nominal Lumen	Beam angle (BA°)	Driver Options	Finish	
Mini Cobra Flex Louvre	<b>G439</b>	Min. <b>0056</b>	<b>97</b>	<b>27</b> 2700K	1W/LED	90 lm/LED	<b>21 / 29 / EL</b>	<b>00</b> No Driver	<b>10</b> ■ Black	
		⋮		<b>30</b> 3000K					<b>11</b> □ White	
		Max. <b>0956</b>		<b>35</b> 3500K					<b>28</b> ■ Brass Polished	
				<b>40</b> 4000K					<b>35</b> ■ Gold	
				<b>75</b> <b>21</b> 2100K					121 lm/LED	
				<b>24</b> 2400K						

**Notes:**

<sup>1</sup> Information in the chart above is related to 3000K LED.

# Driver Options

## Constant Current

### Mini Cobra Flex Louvre



2C07 Constant Current LED Driver. 1 Driver can drive 2-32LEDs, about 956mm Max.

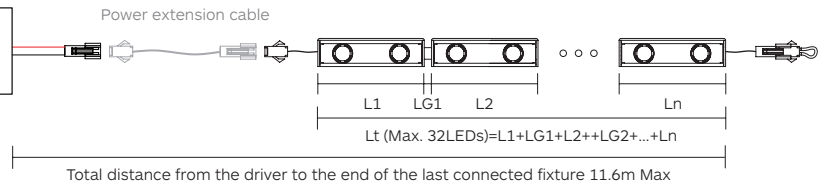

### G439

Power extension cable. Art. **2C47**. 1m (if necessary).

Vin= 180~277V AC 50/60Hz  
Iout= 700mA V=2~57V  
P= 40W Max.  
Dimensions: 123.5x81.5x23mm  
IP20

# Mini Cobra Linealuce

Designed by Ponctuelle



## Body

Surface mounted LED system in extruded aluminium.  
Available in different length configurations starting from 65mm with increment of 60mm.  
Section 14x14mm.  
Constant 30mm pitch between the LED.

Mounting options:  
Integrated magnets for easy installation.  
L mounting brackets.  
U mounting clips.

**\* Plastic free packaging.**

## Accessories

Honeycomb Art. 2D97.  
Color filter Art. 2E41.  
Mounting accessories included.  
Power extension cable Art. 2C47 to be ordered separately.

## Finish

Anodized black, white, brass polished or gold finish.  
Other finish options available on request.

## LED sources

Power LED.  
CRI: 75 & 97 | R9: >90 | CCT: 2100K, 2400K, 2700K, 3000K, 3500K, 4000K.  
3-Step MacAdam.  
Other CRI and CCT options available on request.

## Optic

Lens.  
Beam angle: 21° / 29° / elliptical (22° x 47°).

## Driver

Driver not included to be ordered separately.  
Work with 700 mA Constant Current Driver positioned remotely.

## Applications

Ideal for indirect cove illumination, it creates a wall grazing effect for architectonic surfaces. It is also a great pick also for display showcase illumination.  
Application areas: Cove light, wallwash, residential, hospitality, restaurants, museums, display showcases.

## Related Products

**Mini Cobra Flex** 

**Mini Cobra Linealuce Louvre** 

**Mini Cobra Flex Louvre** 

**Mini Cobra Pro** 

**Mini Cobra Pro Louvre** 

# Mini Cobra Linealuce | G451

**Mini Cobra**  
Linealuce



## Min. L= 65mm (2 x LED)

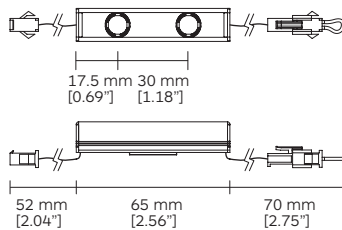

## Mounting options

With magnet L bracket

With mounting U clip

With magnet

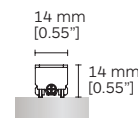
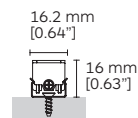
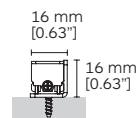

## Accessories

Honeycomb Art. 2D97

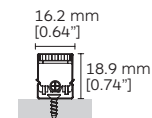

## Max. L= 965mm (32 x LED)

## Increment: 60mm (2.36"), 2 LEDs

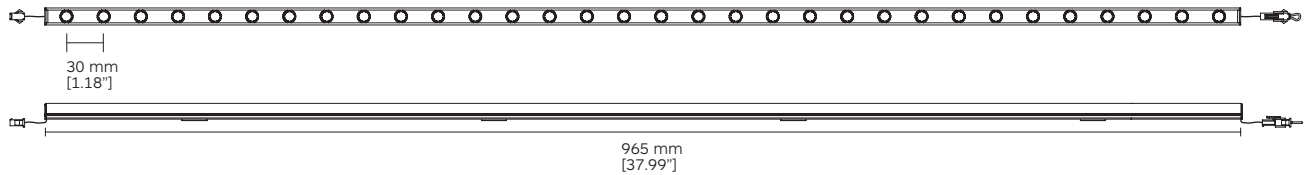

## Available length codes <sup>1</sup>

No. of LEDs	Voltage	LED Power	Length code	Length in mm	Length in inches	Nominal Lumen	No. of LEDs	Voltage	LED Power	Length code	Length in mm	Length in inches	Nominal Lumen
2	3.2V	2W	<b>0065</b>	65	2.55	180 lm	18	28.8V	18W	<b>0545</b>	545	21.45	1620 lm
4	6.4V	4W	<b>0125</b>	125	4.92	360 lm	20	32V	20W	<b>0605</b>	605	23.81	1800 lm
6	9.6V	6W	<b>0185</b>	185	7.28	540 lm	22	35.2V	22W	<b>0665</b>	665	26.18	1980 lm
8	12.8V	8W	<b>0245</b>	245	9.64	720 lm	24	38.4V	24W	<b>0725</b>	725	28.54	2160 lm
10	16V	10W	<b>0305</b>	305	12.00	900 lm	26	41.6V	26W	<b>0785</b>	785	30.90	2340 lm
12	19.2V	12W	<b>0365</b>	365	14.37	1080 lm	28	44.8V	28W	<b>0845</b>	845	33.26	2520 lm
14	22.4V	14W	<b>0425</b>	425	16.73	1260 lm	30	48V	30W	<b>0905</b>	905	35.62	2700 lm
16	25.6V	16W	<b>0485</b>	485	19.09	1440 lm	32	51.2V	32W	<b>0965</b>	965	37.99	2880 lm

Code ordering example: **G 4 5 1 0 0 6 5 - 9 7 2 7 2 1 0 0 1 0**

	Product code*	Length code	>CRI	CCT**	LED Power	Nominal Lumen	Beam angle (BA°)	Driver Options	Finish
Mini Cobra Linealuce	<b>G451</b>	Min. <b>0065</b>	<b>97</b>	<b>27</b> 2700K	1W/LED	90 lm/LED	<b>21 / 29 / EL</b>	<b>00</b> No Driver	<b>10</b> ■ Black
		⋮		<b>30</b> 3000K					<b>11</b> □ White
		Max. <b>0965</b>		<b>35</b> 3500K					<b>28</b> ■ Brass Polished
				<b>40</b> 4000K					<b>35</b> ■ Gold
			<b>75</b>	<b>21</b> 2100K		121 lm/LED			
				<b>24</b> 2400K					

### Notes:

<sup>1</sup> Information in the chart above is related to 3000K LED.



# Driver Options

## Constant Current

### Mini Cobra Linealuce

2C07 Constant Current LED Driver. 1 Driver can drive 2-32LEDs, about 965mm Max.

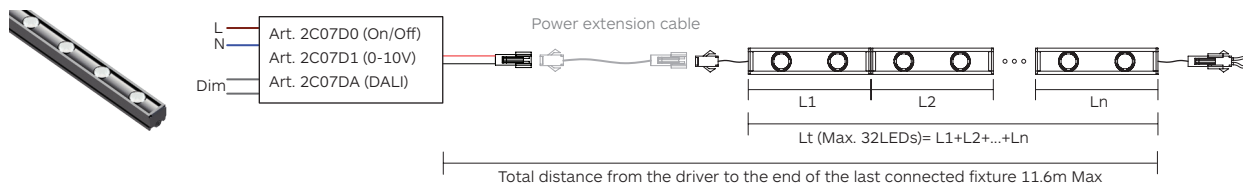

### G451

Power extension cable. Art. **2C47**. 1m (if necessary).

Vin= 180-277V AC 50/60Hz  
Iout= 700mA V=2-57V  
P= 40W Max.  
Dimensions: 123.5x81.5x23mm  
IP20

# Accessories

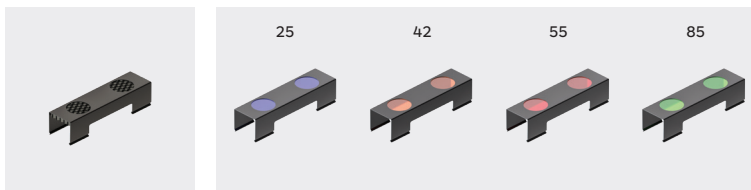

Product / Accessories

Honeycomb

Coloured  
Filters

Finish: 10

Filter colour codes: 25 / 42 / 55 / 85

Mini Cobra Linealuce

**2D97**

**2E41-25**  
**2E41-42**  
**2E41-55**  
**2E41-85**

\* Please refer to the user manuals for further details.

# Mini Cobra Linealuce Louvre

Designed by Ponctuelle



## Body

Surface mounted LED system in extruded aluminium.  
Available in different length configurations starting from 65mm with increment of 60mm.  
Section 14x27mm.  
Constant 30mm pitch between the LED.  
Integrated louvre.

Mounting options:  
Integrated magnets for easy installation.  
L mounting brackets.  
U mounting clips.

**\* Plastic free packaging.**

## Accessories

Mounting accessories included.  
Power extension cable Art. 2C47 to be ordered separately.

## Finish

Anodized black, white, brass polished or gold finish.  
Other finish options available on request.

## LED sources

Power LED.  
CRI: 75 & 97 | R9: >90 | CCT: 2100K, 2400K, 2700K, 3000K, 3500K, 4000K.  
3-Step MacAdam.  
Other CRI and CCT options available on request.

## Optic

Lens.  
Beam angle: 21° / 29° / elliptical (22° x 47°).

## Driver

Driver not included to be ordered separately.  
Work with 700 mA Constant Current Driver positioned remotely.

## Applications

Ideal for indirect cove illumination, it creates a wall grazing effect for architectonic surfaces. It is also a great pick also for display showcase illumination.  
Application areas: Cove light, wall grainger, residential, hospitality, restaurants, museums, display showcases.

## Related Products

**Mini Cobra Linealuce** 

**Mini Cobra Flex** 

**Mini Cobra Flex Louvre** 

**Mini Cobra Pro** 

**Mini Cobra Pro Louvre** 

# Mini Cobra Linealuce Louvre | G452

**Mini Cobra**  
Linealuce  
Louvre



**Min. L= 65mm (2 x LED)**

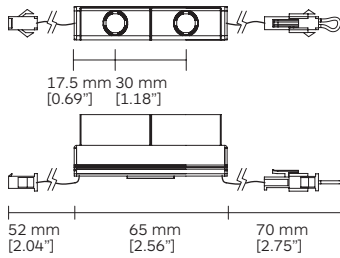

**Mounting options**

With magnet L bracket

With mounting U clip

With magnet

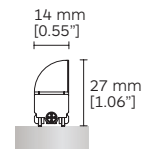
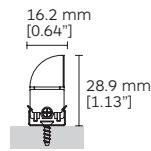
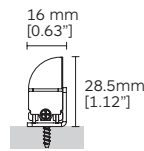

**Max. L= 965mm (32 x LED)**

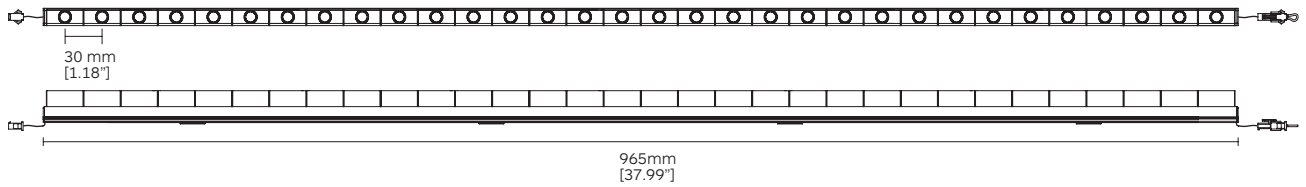

**Available length codes <sup>1</sup>**

No. of LEDs	Voltage	LED Power	Length code	Length in mm	Length in inches	Nominal Lumen	No. of LEDs	Voltage	LED Power	Length code	Length in mm	Length in inches	Nominal Lumen
2	3.2V	2W	<b>0065</b>	65	2.55	180 lm	18	28.8V	18W	<b>0545</b>	545	21.45	1620 lm
4	6.4V	4W	<b>0125</b>	125	4.92	360 lm	20	32V	20W	<b>0605</b>	605	23.81	1800 lm
6	9.6V	6W	<b>0185</b>	185	7.28	540 lm	22	35.2V	22W	<b>0665</b>	665	26.18	1980 lm
8	12.8V	8W	<b>0245</b>	245	9.64	720 lm	24	38.4V	24W	<b>0725</b>	725	28.54	2160 lm
10	16V	10W	<b>0305</b>	305	12.00	900 lm	26	41.6V	26W	<b>0785</b>	785	30.90	2340 lm
12	19.2V	12W	<b>0365</b>	365	14.37	1080 lm	28	44.8V	28W	<b>0845</b>	845	33.26	2520 lm
14	22.4V	14W	<b>0425</b>	425	16.73	1260 lm	30	48V	30W	<b>0905</b>	905	35.62	2700 lm
16	25.6V	16W	<b>0485</b>	485	19.09	1440 lm	32	51.2V	32W	<b>0965</b>	965	37.99	2880 lm

Code ordering example: **G 4 5 2 0 0 6 5 - 9 7 2 7 2 1 0 0 1 0**

	Product code*	Length code	>CRI	CCT**	LED Power	Nominal Lumen	Beam angle (BA°)	Driver Options	Finish
Mini Cobra Linealuce Louvre	<b>G452</b>	Min. <b>0065</b>	<b>97</b>	<b>27</b> 2700K	1W/LED	90 lm/LED	<b>21 / 29 / EL</b>	<b>00</b> No Driver	<b>10</b> ■ Black
		⋮		<b>30</b> 3000K					<b>11</b> □ White
		Max. <b>0965</b>		<b>35</b> 3500K					<b>28</b> ■ Brass Polished
				<b>40</b> 4000K					<b>35</b> ■ Gold
			<b>75</b>	<b>21</b> 2100K		121 lm/LED			
				<b>24</b> 2400K					

**Notes:**

<sup>1</sup> Information in the chart above is related to 3000K LED.

# Driver Options

## Constant Current

### Mini Cobra Linealuce Louvre

2C07 Constant Current LED Driver. 1 Driver can drive 2-32LEDs, about 965mm Max.

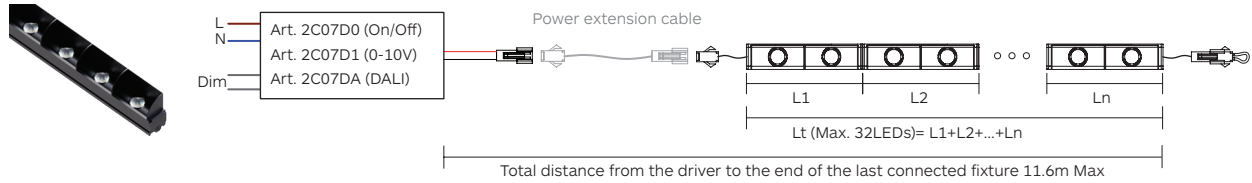

### G452

Power extension cable. Art. **2C47**. 1m (if necessary).

Vin= 180-277V AC 50/60Hz  
Iout= 700mA V=2-57V  
P= 40W Max.  
Dimensions: 123.5x81.5x23mm  
IP20

# Mini Cobra Pro



## Body

Surface mounted modular system in die cast aluminium. Available in different length configurations based on a 62mm link (2 LED per link) with a 60mm increment. Section 15x17mm. Its flexible structure maintain a constant 30mm pitch between the LED.

Mounting options:  
Integrated magnets for easy installation.  
L mounting brackets included.

**\* Plastic free packaging.**

## Accessories

Mounting accessories not included.  
Power extension cable Art. 2C47 to be ordered separately.

## Finish

Anodized black, white, brass polished or gold finish.  
Other finish options available on request.

## LED sources

Power LED.  
CRI: 75 & 97 | R9: >90 | CCT: 2100K, 2400K, 2700K, 3000K, 3500K, 4000K.  
3-Step MacAdam.  
Other CRI and CCT options available on request.

## Optic

Lens.  
Beam angle: 21° / 31° / elliptical (22° x 47°).

## Driver

Driver not included to be ordered separately.  
Work with 700 mA Constant Current Driver positioned remotely.

## Applications

Ideal for indirect cove illumination, it creates a wall grazing effect for columns and curved architectural surfaces. It is also a great pick also for display showcase illumination. Application areas: Cove light, wallwash, residential, hospitality, restaurants, museums, display showcases.

## Related Products

**Mini Cobra  
Linealuce**



**Mini Cobra  
Flex**



**Mini Cobra  
Linealuce  
Louvre**



**Mini Cobra  
Flex Louvre**



**Mini Cobra  
Pro Louvre**



# Mini Cobra Pro | G462



**Mini Cobra**  
Pro

**Min. L= 62mm (2 x LED) 1 Link**

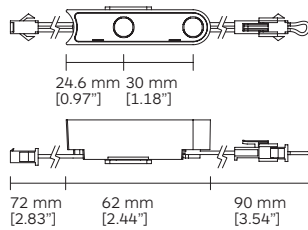

**Mounting options**

With magnet & L bracket

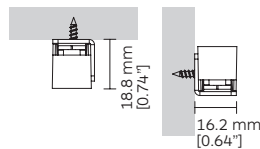

With adjustable bracket: Narrow or Wide bracket

Art. 2D03

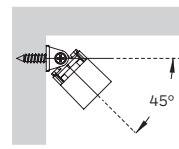

Art. 2D04

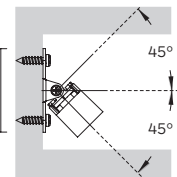

With magnet

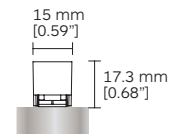

**Max. L= 962mm (32 x LED) 16 Links**

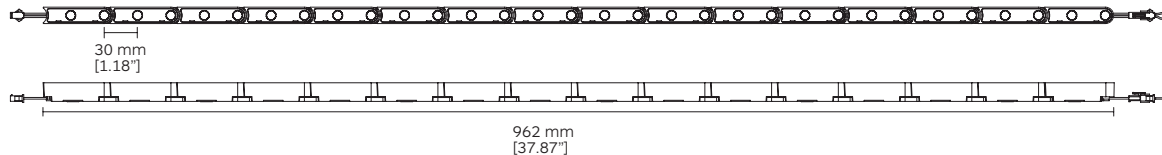

**Available length codes <sup>1</sup>**

No. of Links	Voltage	LED Power	Length code	Length in mm	Length in inches	Nominal Lumen	No. of Links	Voltage	LED Power	Length code	Length in mm	Length in inches	Nominal Lumen
1	3.2V	2W	<b>0062</b>	62	2.44	180 lm	9	28.8V	18W	<b>0542</b>	542	21.33	1620 lm
2	6.4V	4W	<b>0122</b>	122	4.80	360 lm	10	32V	20W	<b>0602</b>	606	23.70	1800 lm
3	9.6V	6W	<b>0182</b>	182	7.16	540 lm	11	35.2V	22W	<b>0662</b>	662	26.06	1980 lm
4	12.8V	8W	<b>0242</b>	242	9.52	720 lm	12	38.4V	24W	<b>0722</b>	722	28.42	2160 lm
5	16V	10W	<b>0302</b>	302	11.88	900 lm	13	41.6V	26W	<b>0782</b>	782	30.78	2340 lm
6	19.2V	12W	<b>0362</b>	362	14.25	1080 lm	14	44.8V	28W	<b>0842</b>	842	33.14	2520 lm
7	22.4V	14W	<b>0422</b>	422	16.61	1260 lm	15	48V	30W	<b>0902</b>	902	35.51	2700 lm
8	25.6V	16W	<b>0482</b>	482	18.97	1440 lm	16	51.2V	32W	<b>0962</b>	962	37.87	2880 lm

Code ordering example: **G 4 6 2 0 0 6 2 - 9 7 2 7 2 1 0 0 1 0**

	Product code*	Length code	>CRI	CCT**	LED Power	Nominal Lumen	Beam angle (BA°)	Driver Options	Finish
Mini Cobra Pro	<b>G462</b>	Min. <b>0062</b>	<b>97</b>	<b>27</b> 2700K	1W/LED	90 lm/LED	<b>21 / 29 / EL</b>	<b>00</b> No Driver	<b>10</b> ■ Black
		⋮		<b>30</b> 3000K					<b>11</b> □ White
		Max. <b>0962</b>		<b>35</b> 3500K					<b>28</b> ■ Brass Polished
				<b>40</b> 4000K					<b>35</b> ■ Gold
			<b>75</b>	<b>21</b> 2100K		121 lm/LED			
				<b>24</b> 2400K					

**Notes:**

<sup>1</sup> Information in the chart above is related to 3000K LED.

# Driver Options

## Constant Current

### Mini Cobra Pro

2C07 Constant Current LED Driver. 1 Driver can drive 2-32LEDs, about 962mm Max.

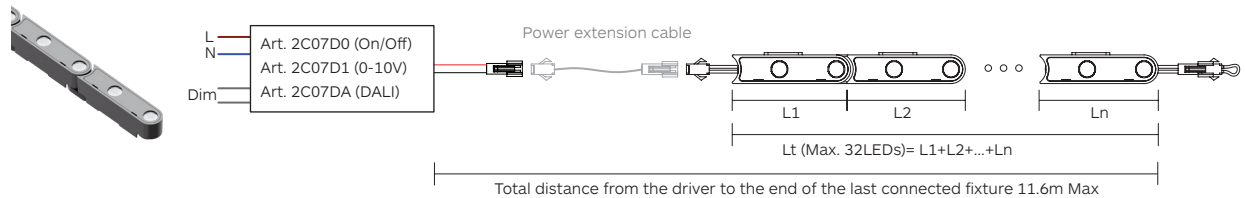

### G462

Power extension cable. Art. **2C47**. 1m (if necessary).

Vin= 180-277V AC 50/60Hz  
 Iout= 700mA V=2-57V  
 P= 40W Max.  
 Dimensions: 123.5x81.5x23mm  
 IP20

# Accessories



Narrow Bracket Adjustable

Finish: 10



Wide Bracket Adjustable

Finish: 10

Product / Accessories

Mini Cobra Pro

**2D03**

**2D04**

\* Please refer to the user manuals for further details.

# Mini Cobra Pro Louvre



## Body

Surface mounted modular system in die cast aluminium.  
Available in different length configurations based on a 62mm link (2 LED per link) with a 60mm increment.  
Section 15x30mm.  
Its flexible structure maintain a constant 30mm pitch between the LED.

Mounting options:  
Integrated magnets for easy installation.  
L mounting brackets included.  
Integrated plastic louvre.

**\* Plastic free packaging.**

## Accessories

Mounting accessories not included.  
Power extension cable Art. 2C47 to be ordered separately.

## Finish

Anodized black, white, brass polished or gold finish.  
Other finish options available on request.

## LED sources

Power LED.  
CRI: 75 & 97 | R9: >90 | CCT: 2100K, 2400K, 2700K, 3000K, 3500K, 4000K.  
3-Step MacAdam.  
Other CRI and CCT options available on request.

## Optic

Lens.  
Beam angle: 21° / 31° / elliptical (22° x 47°).

## Driver

Driver not included to be ordered separately.  
Work with 700 mA Constant Current Driver positioned remotely.

## Applications

Ideal for indirect cove illumination, it creates a wall grazing effect for columns and curved architectonic surfaces. It is also a great pick also for display showcase illumination.  
Application areas: Cove light, wallwash, residential, hospitality, restaurants, museums, display showcases.

## Related Products

**Mini Cobra Linealuce** 

**Mini Cobra Flex** 

**Mini Cobra Linealuce Louvre** 

**Mini Cobra Flex Louvre** 

**Mini Cobra Pro** 



# Mini Cobra Pro Louvre | G463

Mini Cobra  
Pro Louvre



## Min. L= 62mm (2 x LED) 1 Link

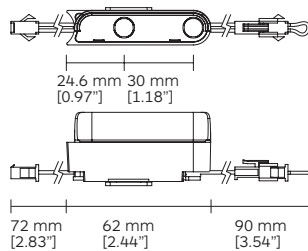

## Mounting options

With magnet & L bracket

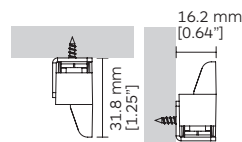

With adjustable bracket: Narrow or Wide bracket

Art. 2D03

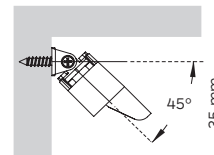

Art. 2D04

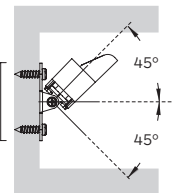

With magnet

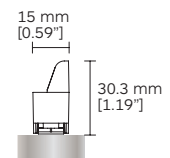

## Max. L= 962mm (32 x LED) 16 Links

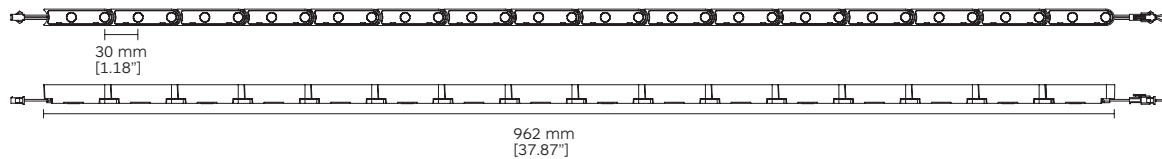

## Available length codes <sup>1</sup>

No. of Links	Voltage	LED Power	Length code	Length in mm	Length in inches	Nominal Lumen	No. of Links	Voltage	LED Power	Length code	Length in mm	Length in inches	Nominal Lumen
1	3.2V	2W	<b>0062</b>	62	2.44	180 lm	9	28.8V	18W	<b>0542</b>	542	21.33	1620 lm
2	6.4V	4W	<b>0122</b>	122	4.80	360 lm	10	32V	20W	<b>0602</b>	606	23.70	1800 lm
3	9.6V	6W	<b>0182</b>	182	7.16	540 lm	11	35.2V	22W	<b>0662</b>	662	26.06	1980 lm
4	12.8V	8W	<b>0242</b>	242	9.52	720 lm	12	38.4V	24W	<b>0722</b>	722	28.42	2160 lm
5	16V	10W	<b>0302</b>	302	11.88	900 lm	13	41.6V	26W	<b>0782</b>	782	30.78	2340 lm
6	19.2V	12W	<b>0362</b>	362	14.25	1080 lm	14	44.8V	28W	<b>0842</b>	842	33.14	2520 lm
7	22.4V	14W	<b>0422</b>	422	16.61	1260 lm	15	48V	30W	<b>0902</b>	902	35.51	2700 lm
8	25.6V	16W	<b>0482</b>	482	18.97	1440 lm	16	51.2V	32W	<b>0962</b>	962	37.87	2880 lm

Code ordering example: **G 4 6 3 0 0 6 2 - 9 7 2 7 2 1 0 0 1 0**

	Product code*	Length code	>CRI	CCT**	LED Power	Nominal Lumen	Beam angle (BA°)	Driver Options	Finish	
Mini Cobra Pro Louvre	<b>G463</b>	Min. <b>0062</b>	<b>97</b>	<b>27</b> 2700K	1W/LED	90 lm/LED	<b>21 / 31 / EL</b>	<b>00</b> No Driver	<b>10</b> ■ Black	
		⋮		<b>30</b> 3000K					<b>11</b> □ White	
		Max. <b>0962</b>		<b>35</b> 3500K					<b>28</b> ■ Brass Polished	
				<b>40</b> 4000K					<b>35</b> ■ Gold	
				<b>75</b> <b>21</b> 2400K					121 lm/LED	
				<b>24</b> 2400K						

## Notes:

<sup>1</sup> Information in the chart above is related to 3000K LED.

# Driver Options

## Constant Current

### Mini Cobra Pro Louvre



L  
N  
Dim

Art. 2C07D0 (On/Off)  
Art. 2C07D1 (0-10V)  
Art. 2C07DA (DALI)

2C07 Constant Current LED Driver. 1 Driver can drive 2-32LEDs, about 962mm Max.

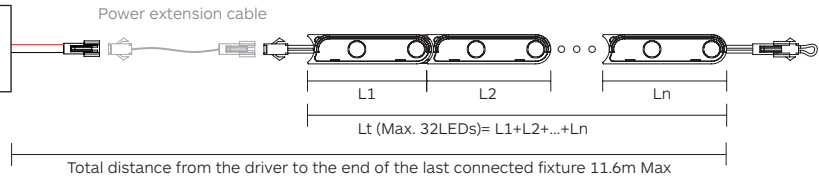

### G463

Power extension cable. Art. **2C47**. 1m (if necessary).

Vin= 180-277V AC 50/60Hz  
Iout= 700mA V=2-57V  
P= 40W Max.  
Dimensions: 123.5x81.5x23mm  
IP20

# Accessories



Product / Accessories

Narrow Bracket  
Adjustable

Wide Bracket  
Adjustable

Finish: 10

Finish: 10

Mini Cobra Pro Louvre

**2D03**

**2D04**

\* Please refer to the user manuals for further details.