

formalighting

Zero Mini Point Series

2026

Zero Mini Point Series

Zero 8



Zero 12



Zero 15 Zoom



Zero 25



Revolutionary miniature series

Four dimensions

Refined Impact

G956



Ø 12

G958



Ø 15

G957



Ø 25

*Zero Ø 12, Ø 15 & Ø 25 in deep recessed mounting
Zero Ø 8 in recessed trim mounting*

G955



Ø 8

Your showcase lighting solution

Ideal for extra-shallow ceiling voids, whether mounted on the wall or ceiling.

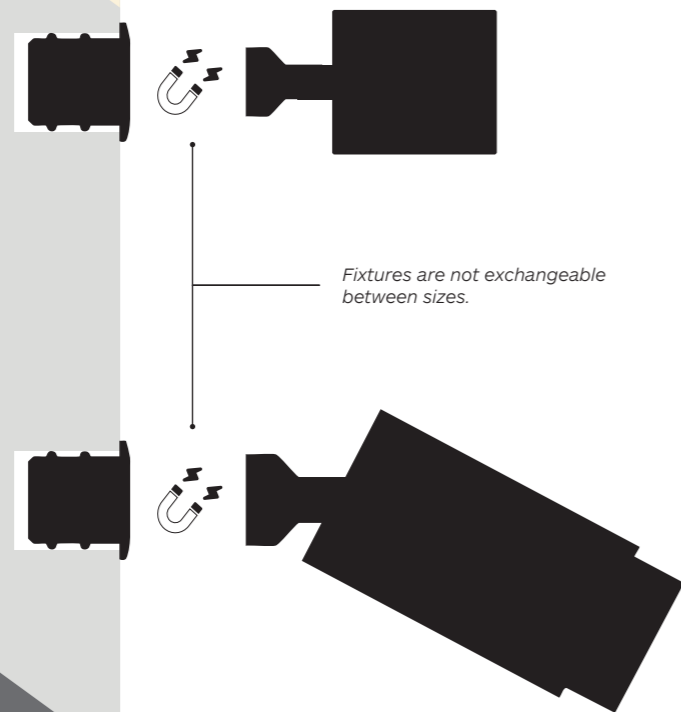

Recessed trim

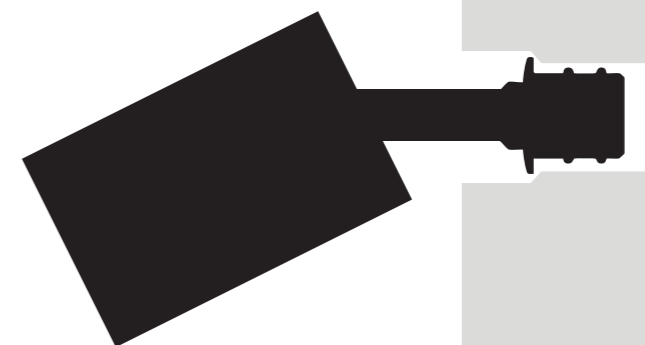

Deep recessed



Adaptability & Simplicity

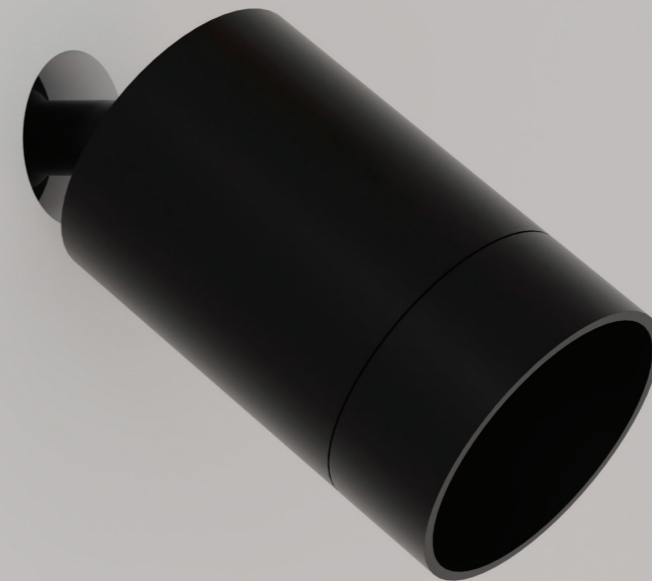
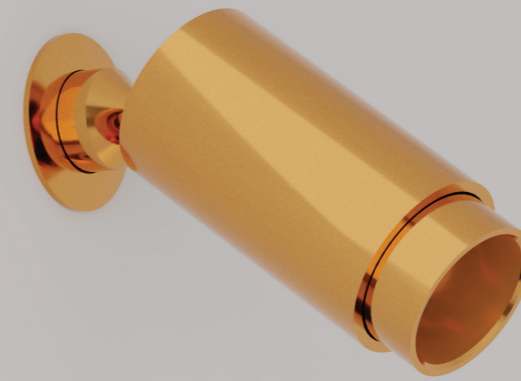
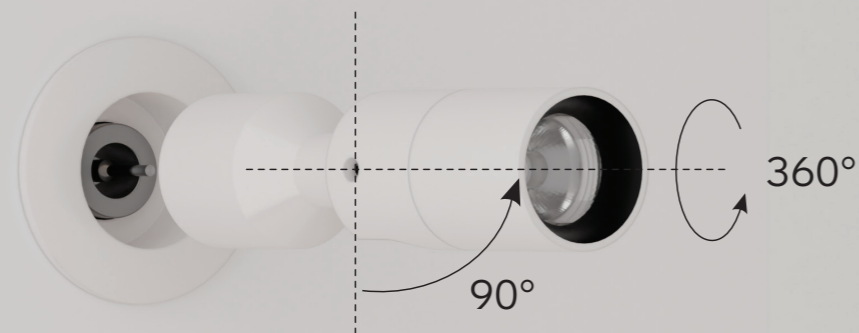

Innovative Modular Lighting System

The Zero Mini Point series from formalighting is a revolutionary, modular lighting system with minimalist design.

Designed for shallow compact spaces, this series offers discreetly recessed miniature connectors that conceal cables and form the base on which energy-efficient, high performance lightheads can be easily attached.

An easy to install, genuine plug & play system with complete flexibility, modular design and toolless magnetic connection. Ideal for application areas that require showcase and focus lighting solutions such as museums and retail.



Tool-free installation



Simple magnet attachment



90° degree tilting with 360° horizontal rotation



Multiple sizes

Zero Mini Point

Recessed

The Zero Mini Point seamlessly integrates into your ceiling or wall, presenting a clean, minimalist aperture only 13mm deep. It is the definitive choice for ultra-shallow voids.

Beyond its discreet profile, it offers unparalleled functional freedom. Effortlessly direct light exactly where you need it with 90° tilt and 360° rotation. The magnetic, toolless connection empowers you to design and rearrange your lighting scheme instantly, creating captivating focal points for any display or showcase application.

Compatible with: Zero 8, Zero 12, Zero 15 Zoom, and Zero 25 light modules.

LED Sources:

High Rendering:
CRI: 97 | CCT: 2700K, 3000K, 3500K, 4000K.
Other CRI and CCT options available on request.

- 10 - Black
- 11 - White
- 35 - Gold



Zero Mini Point

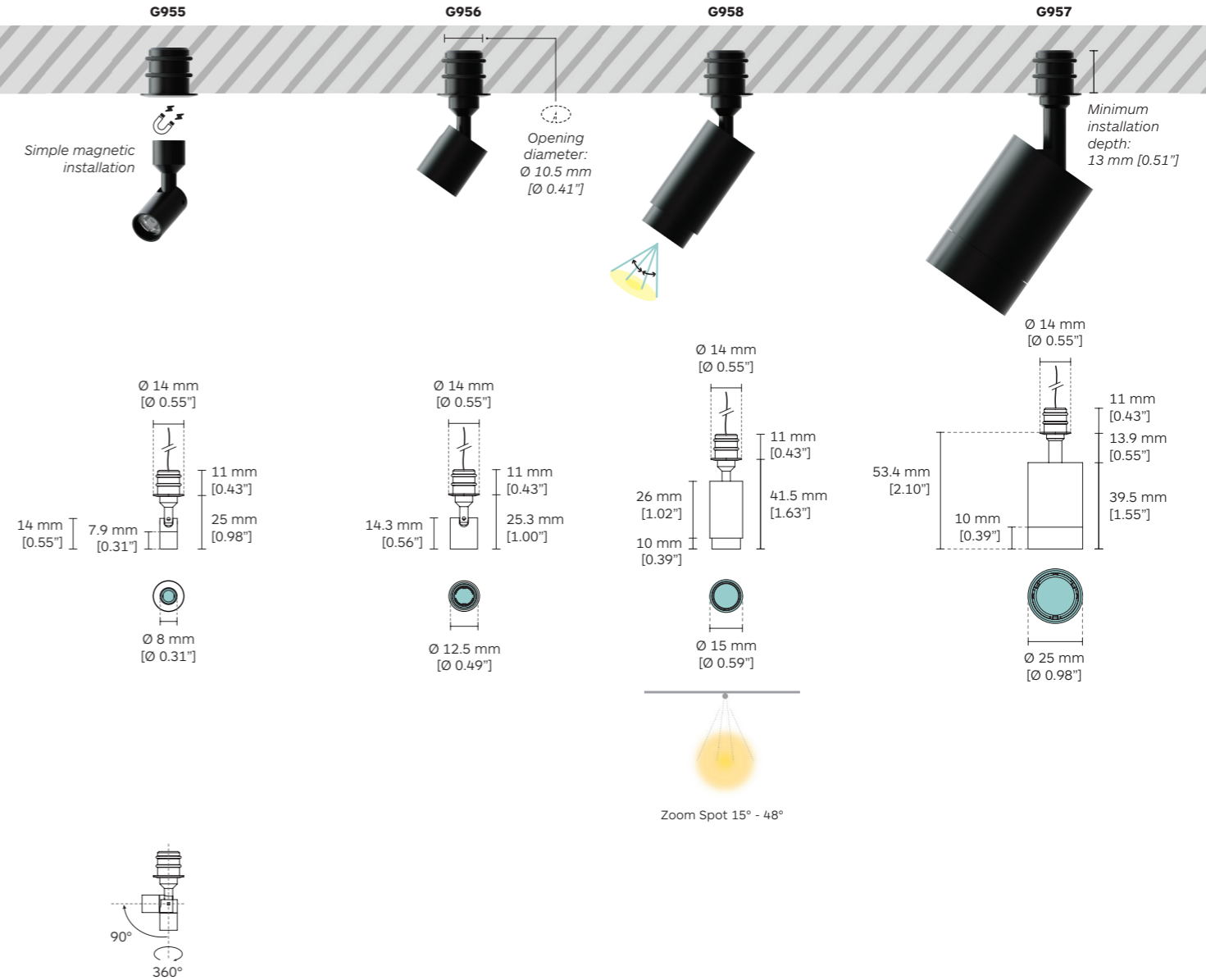

	Product Code ¹	Light Source Code	LED Power	Nominal Lumen	Beam Angle (BA°)	Dimming Options	CCT Options ²
CRI > 97 3000K High Rendering	Zero 8	G955	BN12	0.6W	64 lm	D1 0-10V Dim	27 2700K
	Zero 12	G956		1W	117 lm	ND No Driver (CC Fixtures)	30 3000K
	Zero 15 Zoom	G958		1.2W	132 lm		35 3500K
	Zero 25	G957		2.1W	207 lm		40 4000K

¹ For complete code ordering information, please see page 23. ² Other CCT options available on request. For the most updated product information, please go to our website.

G955 EL = Elliptical Beam (29° x 44°).
G956 EL = Elliptical Beam (15° - 48°).
BS = Beam Shaping.

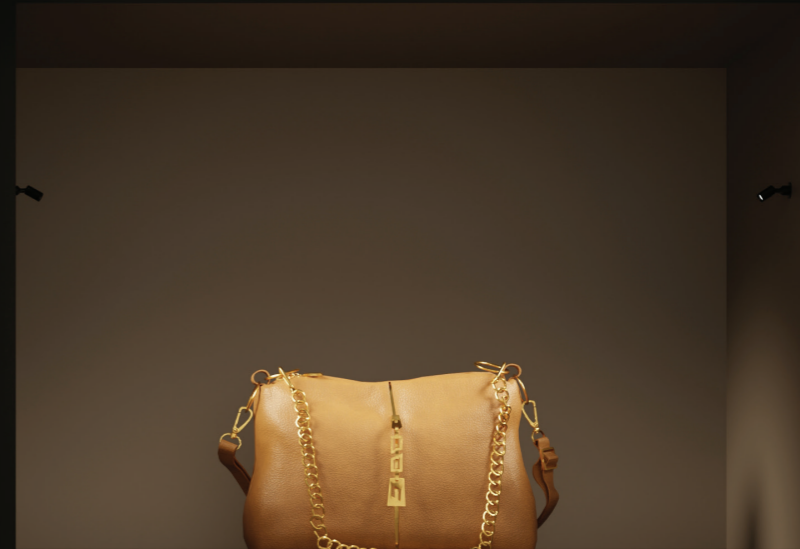

Wiring Diagram

Power supply for Zero Mini Point

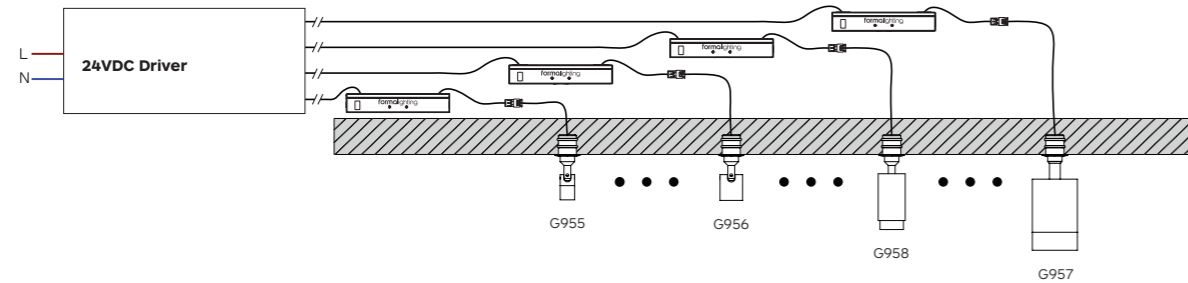

Driver and cable specifications

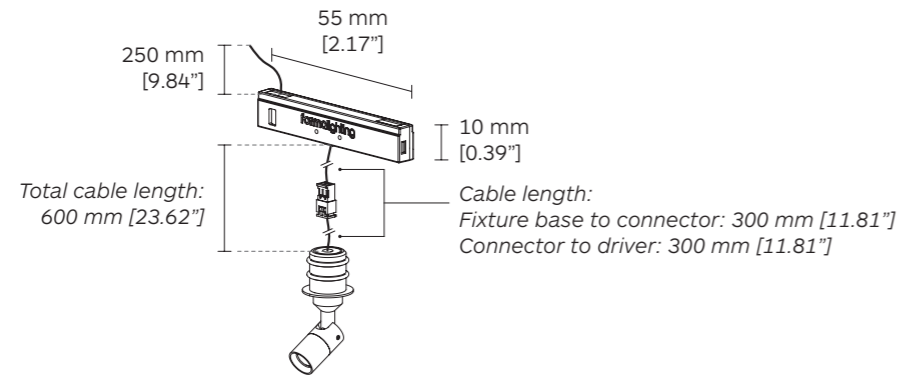

Symbols & Icons

Code system

Global presence

Power Supply



Power Supply
IP20

Vin = 220-240VAC 50/60Hz
Vout = 24VDC 2.5A 60W Max.



Power Supply
IP20

Vin = 220-240VAC 50/60Hz
Vout = 24VDC 5A 120W Max.

Code	G2D1	G2D2
Size	180(L) x 52(W) x 30(H)	300(L) x 40(W) x 30(H)

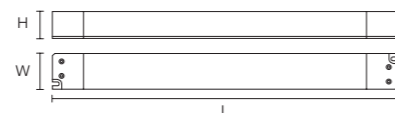



Symbols & Icons

Round ceiling cut 

Square ceiling cut 

Zoom 

CLASS I
Luminaires of insulation Class I - with earth connector. 

CLASS II
Luminaires of insulation Class II - With safety isolation, this means the tension conduction element are protected by additional isolation. The isolation of an earth wire it is not necessary and the connection to it is not allowed. 

CLASS III
Luminaires of insulation Class III - designed for operation of protected low voltage supplied (>42V). 

Degree of Ingress Protection* 

24V input integrated. 

Certification Icons

CE Mark - Product complies with CE Standard. 

UL Mark - Product complies with USA & Canada Standard. 

CSA Mark - Product complies with USA & Canada Standard. 

CB Mark - Product complies with CB Standard. 

KC Mark - Product complies with Korean Standard. 

Other third party product approvals
Our products include electrical and electronic components that carry other worldwide Test House approvals such as those shown: 

Body Color



10 Black (RAL 9004)



11 White (RAL 9003)

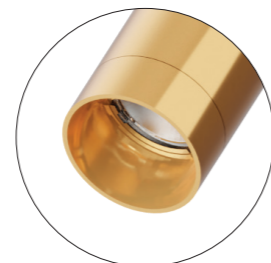

35 Gold

Code system

Code ordering example: **G 9 5 5 B N 1 2 - 9 7 3 5 2 5 D 1 1 0**

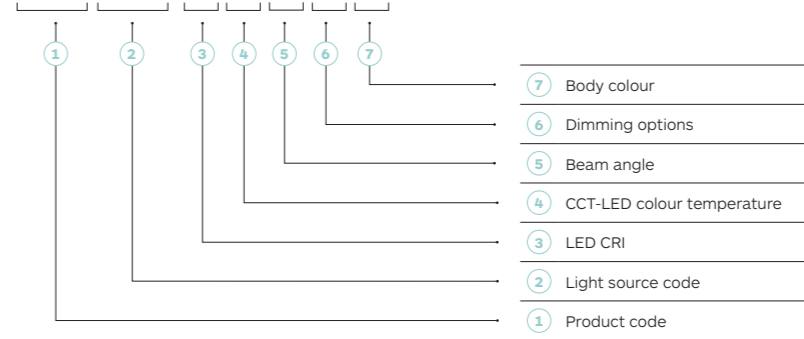

LED CRI	CCT-LED Colour temperature	Dimming Options	Body Colour
97 CRI > 97	27 Warm White 2700K	D1 0-10V Dim	10 Black (RAL 9004)
	30 Warm White 3000K	ND No Driver (CC Fixtures)	11 White (RAL 9003)
	35 Warm White 3500K		35 Gold
	40 Neutral White 4000K		

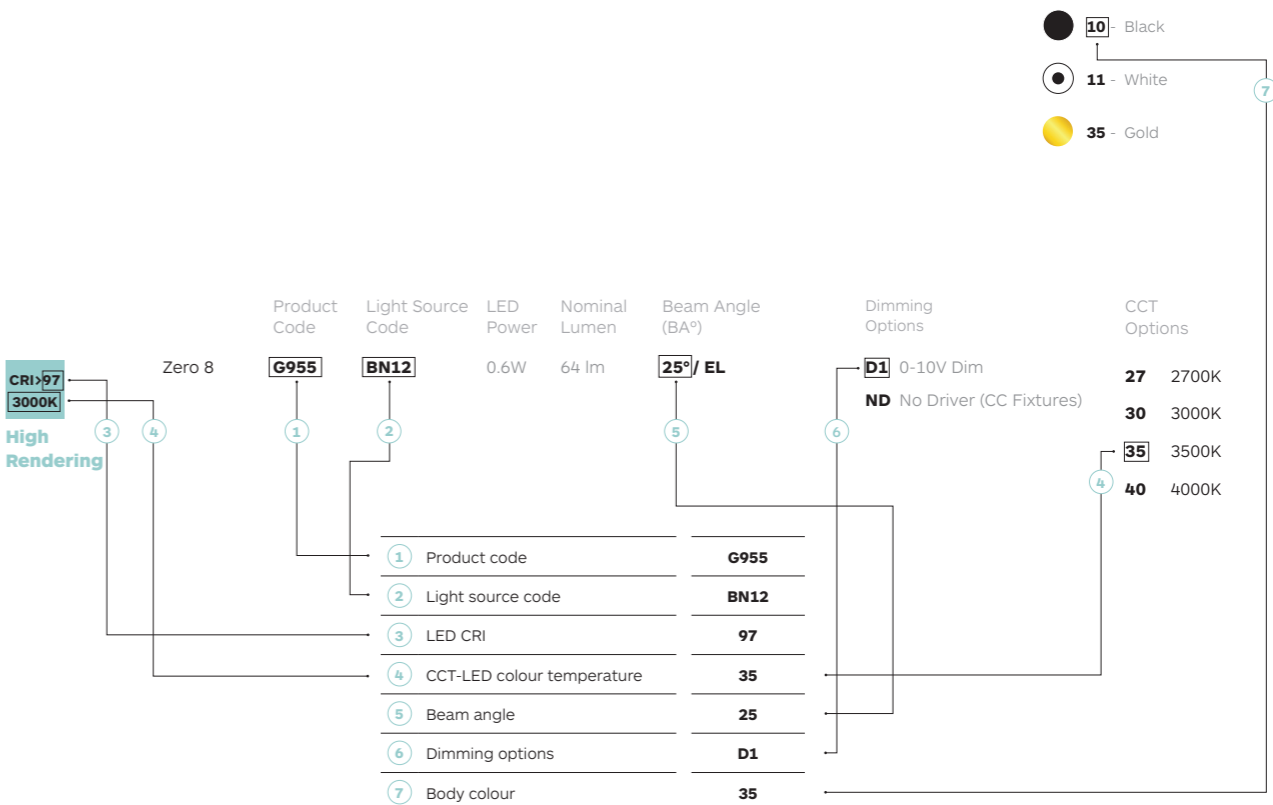

Global presence

Celebrating over 50 years of vision, dedication and innovation, formalighting's versatile and high-quality product offerings extends internationally via our headquarters in Hong Kong, London, Milan and Shanghai.

Our well chosen and selected partners as well as our affiliated international offices broaden our global presence further in markets such as USA, Australia, Japan, South East Asia, India and the Middle East.

Through our commitment to growth and investment within formalighting's professional team, infrastructure and product ranges, we are able to provide increasing service to our global retail and hospitality clients as well as lighting designers and specifiers strengthening our position as a leading international supplier of innovative architectural lighting solutions and systems.

With over 50 years' experience in designing and manufacturing architectural lighting, formalighting's comprehensive portfolio offers a competitive range of European designed and expertly engineered products that carry CB, CE, CCC and UL certifications.

Furthermore formalighting's latest award-winning motorized range of track, pendant, and recessed fixtures, featuring remote-controlled adjustable pan and tilt, dim, dim to warm, tuneable white and beam shaping lens, are available worldwide incorporating the latest, most advanced lighting technologies.

MILAN

EUROPE HEADQUARTERS

Tel (+39) 02 9354 0300

Fax (+39) 02 9343 5117

E- mail info-europe@formalighting.com

HONG KONG

ASIA HEADQUARTERS

Tel (+852) 2516 6500

Fax (+852) 2516 6525

E- mail info-asia@formalighting.com

NEW YORK

LOCAL SALES OFFICE

E- mail info-us@formalighting.com

SHANGHAI

LOCAL SALES OFFICE

E- mail info-china@formalighting.com

LONDON

LOCAL SALES OFFICE

E- mail info-uk@formalighting.com

AUSTRALIA

LOCAL SALES OFFICE

Tel (+61) 488 567 388

E- mail info-australia@formalighting.com

INDIA

LOCAL SALES OFFICE

Tel (+91) 9686351257

E- mail info-india@formalighting.com

formalighting is constantly developing and improving its products therefore all information, drawings illustrations, specifications, photometric values in this catalogue are indicatives and shall not form part of any commitment by our company that reserves the right to change specifications without prior notification or public announcement.

Technical information on the installation-instruction has precedence over the information in the catalogue.

Our general terms and conditions shall apply notwithstanding any stipulation on the contrary to all the orders and agreement with formalighting. You can obtain a copy of these conditions on demand.

Publication date: June 2026

©Copyright formalighting

With thanks to all contributors for the realization of this catalogue

Designed by formalighting's Graphic Design Department

No part of this catalogue may be copied without written authorization of formalighting

Zero Mini Point Series 2026

formalighting

MILAN

-

LONDON

-

USA

-

HONG KONG

-

SHANGHAI

-

INDIA