



formalighting

TicTok & Viivo Series

2026

TicTok & Viivo Series

TicTok Series

VS

Viivo Series

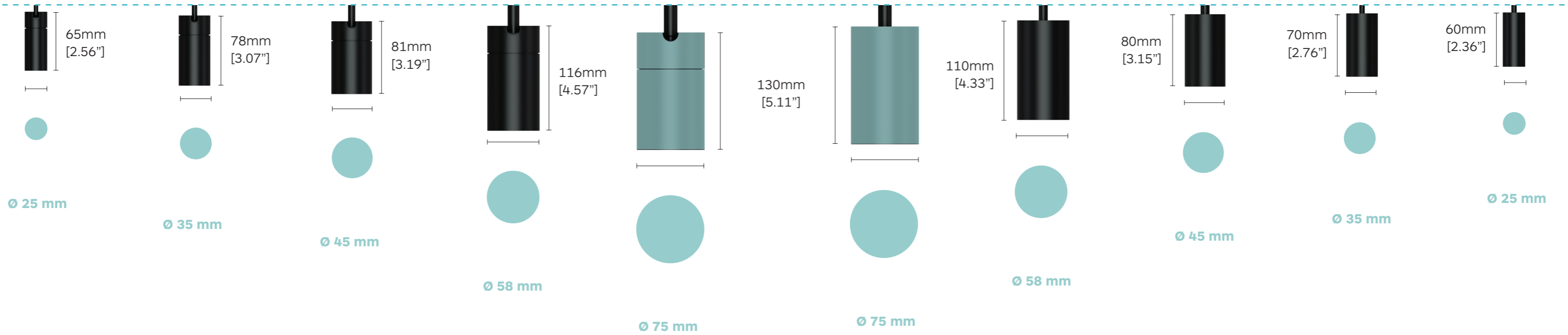
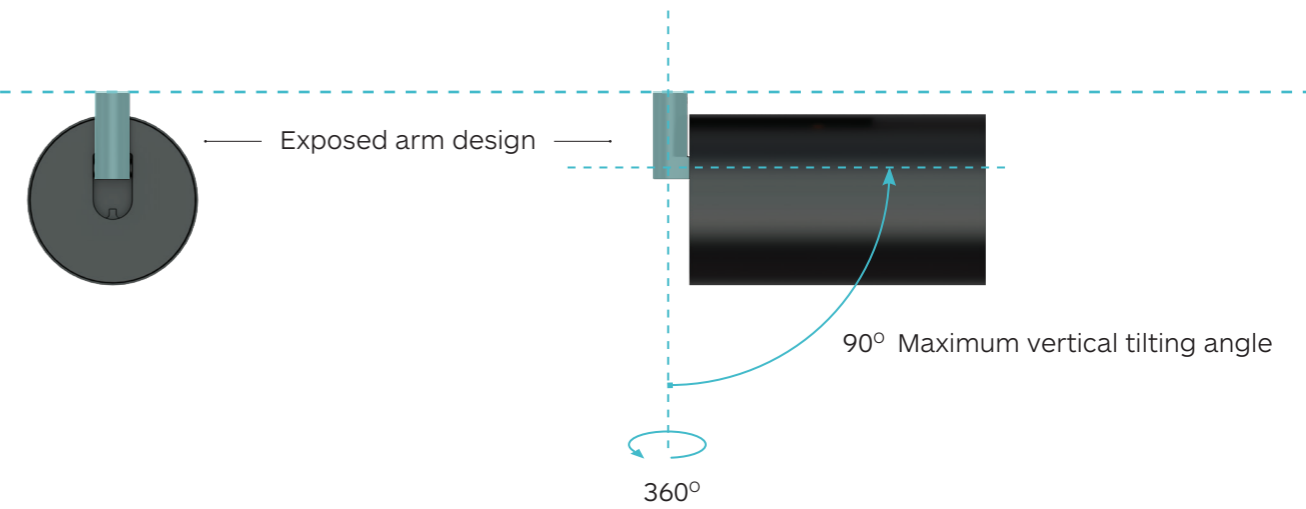
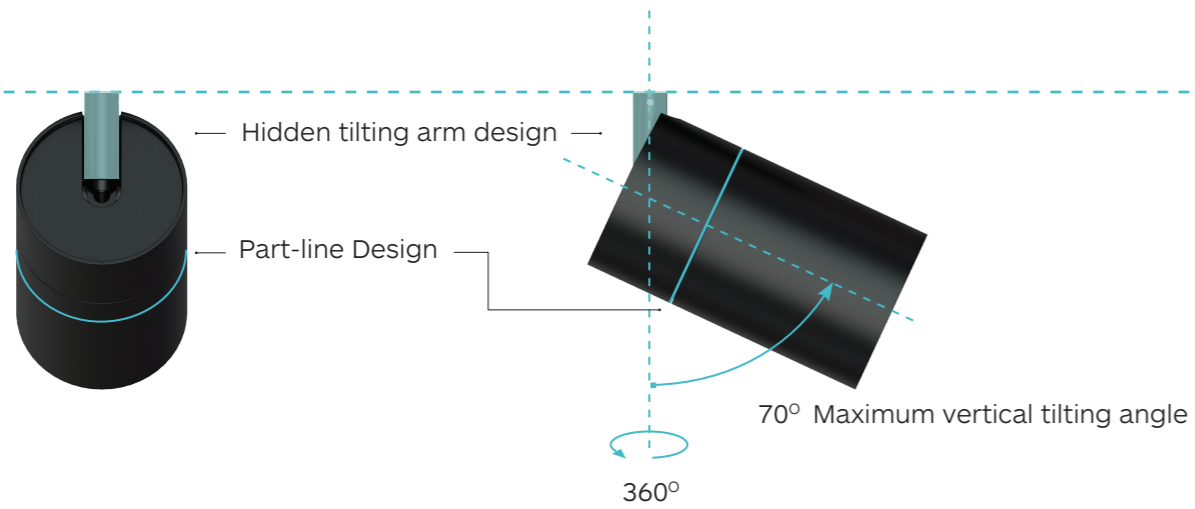

TicTok & Viivo Series

Mounting Options

Semi-Recessed

Mono Point

EVO Track

Curved EVO Track

Micro Track

Eurotype Track

Dimension & Technical Data

	Ø 25			Ø 35		Ø 45				Ø 58				Ø 75																	
	TicTok	TicTok & TicTok Long Arm	TicTok Twins	TicTok & TicTok Long Arm		TicTok Twins		TicTok & TicTok Long Arm TicTok Zoom & TicTok Zoom Long Arm				TicTok & TicTok Long Arm TicTok Zoom & TicTok Zoom Long Arm																			
	Viivo	Viivo & Viivo Long Arm	Viivo Twins	Viivo & Viivo Long Arm		Viivo Twins		Viivo & Viivo Long Arm Viivo Zoom & Viivo Zoom Long Arm				Viivo & Viivo Long Arm Viivo Zoom & Viivo Zoom Long Arm																			
						Zoom				Zoom				Zoom																	
CRI	CRI > 90			CRI > 90		CRI > 97		CRI > 90		CRI > 97		CRI > 90		CRI > 97		CRI > 90		CRI > 97		CRI > 93		CRI > 98									
LED Power	3.4W			Up to 5W		5.5W		Up to 10W		Up to 15W		Up to 15W		19W		18W															
Max Nominal Lumen	370 lm			691 lm		620 lm		634 lm		606 lm		1101 lm		975 lm		1632 lm		1418 lm		1632 lm		1418 lm		1937 lm		1651 lm		2305 lm		1765 lm	
Beam Angle	15° 20° 32°			5° 20° 24° 38°		15° to 47°		12° 18° 26° 38°		17° to 34°		12° 18° 26° 38°		15° to 47°		14° 26° 37°															
Certification																															

Information in the chart above is related to 3000K. Wattage may change depending on beam angle and CCT combinations. Please go to our website www.formalighting.com, for the complete product information.

TicTok Semi Recessed

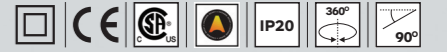







TicTok Semi-Recessed adds a touch of class to the space, the slender base with an integrated power supply brings extra flair and elegance.

TicTok Series focuses on eco-friendly design and modularity. TicTok's tool-free and interchangeable LED module facilitates design flexibility and ease of on-site maintenance.

The tool-free interchangeable LED module is available in $\varnothing 25$, $\varnothing 35$, $\varnothing 45$, $\varnothing 58$ and $\varnothing 75$ mm head sizes, trim, and trimless. It provides full versatility with tiltable 70° and rotatable 350° angles: an eco-friendly onsite maintainable solution.

For complete product information please visit our website.

-  **1Y** - Embossed Matt Total White
-  **54** - Embossed Matt White
-  **65** - Embossed Matt Black
-  **11** - White
-  **10** - Black
-  **27** - Chrome Polished

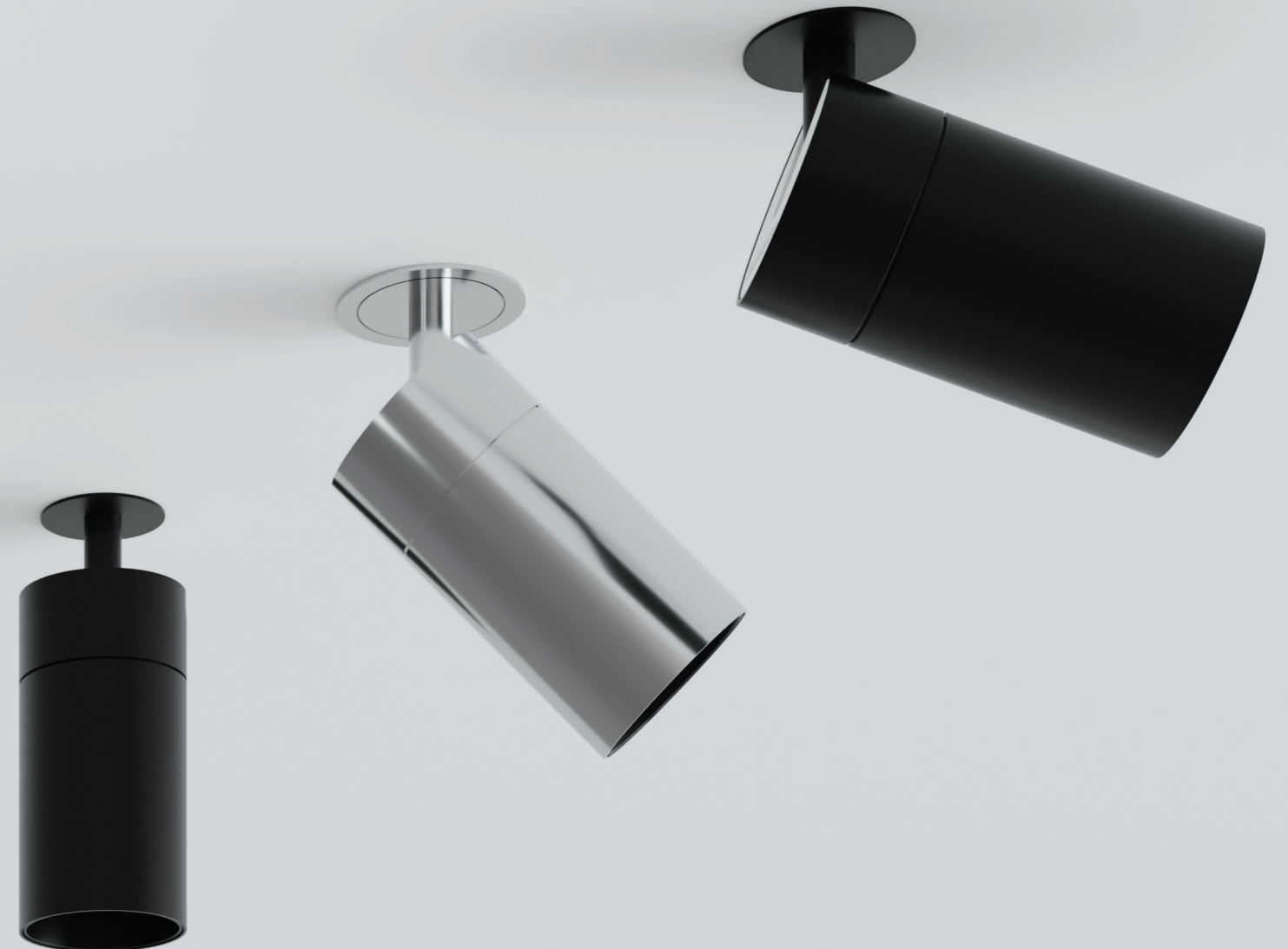



TicTok & Viivo

Semi Recessed

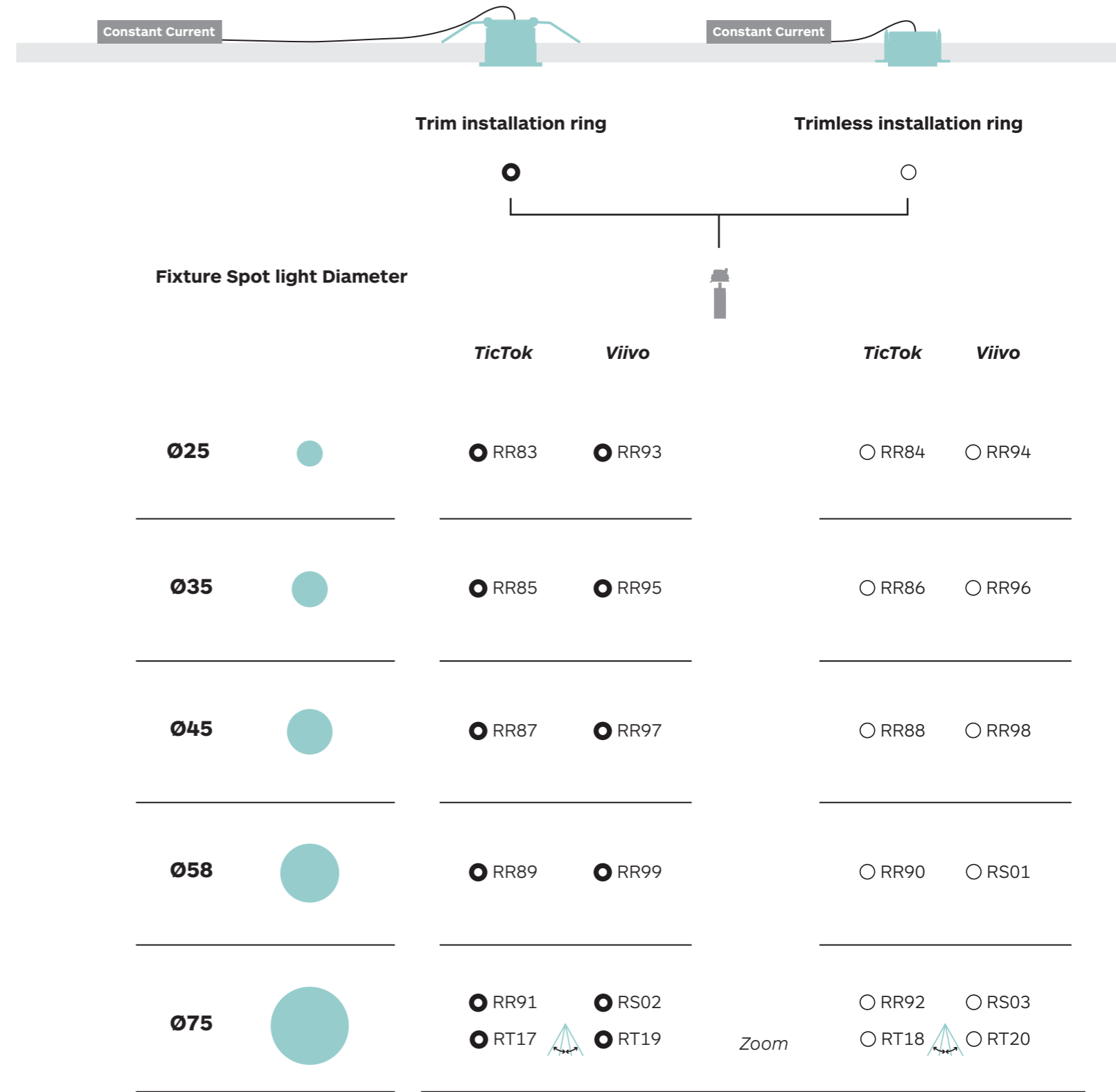

For related accessories, please see page 50.

Viivo Semi Recessed



Viivo Semi-Recessed adds a touch of class to the space, the slender base with an integrated power supply brings extra flair and elegance.

Viivo Series focuses on eco-friendly design and modularity. Viivo's tool-free and interchangeable LED module facilitates design flexibility and ease of on-site maintenance.

The tool-free interchangeable LED module is available in Ø25, Ø35, Ø45, Ø58 and Ø75mm head sizes, trim, and trimless. It provides full versatility with tiltable 90° and rotatable 350° angles: an eco-friendly onsite maintainable solution.

For complete product information please visit our website.



- 1Y - Embossed Matt Total White
- 54 - Embossed Matt White
- 65 - Embossed Matt Black
- 11 - White
- 10 - Black
- 27 - Chrome Polished

TicTok & Viivo Semi Recessed



TicTok Mono Point



- 1Y - Embossed Matt Total White
- 54 - Embossed Matt White
- 11 - White
- 65 - Embossed Matt Black
- 10 - Black
- 27 - Chrome Polished



The TicTok Mono Point is a revolutionary lighting system featuring interchangeable components that are seamlessly integrated into the ceiling with a minimalist design.

Choose from recessed trim, trimless, and surface mount. Mono Point is ideal for any ceiling type and is compatible with a range of TicTok spotlights Ø35mm, Ø45mm, Ø58mm and Ø75mm. Each light head tilts up to 70° and rotates 360° horizontally.

Mix and match to create your custom arrangement; whether mounted on the wall or ceiling, it adds a dramatic and refined touch to any space.

For complete product information please visit our website.

TicTok & Viivo

Mono Point

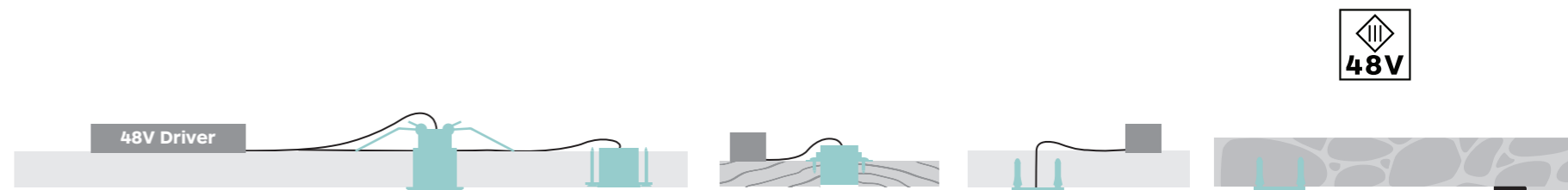
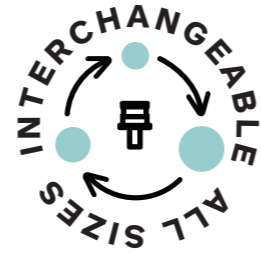

Installation Kit:

	Recessed		Rear Access	Surface Mounted	Soft Track System
	Trim	Trimless	Trimless		
	Art. 2H93 ¹	Art. 2H92 ¹	Art. 2H86 ¹	Art. 2H87 ¹	Art. 2J16 ¹

Fixture Spot light Diameter

Fixture Spot light Diameter	TicTok		Viivo	
	TicTok	Viivo	TicTok	Viivo
Ø35	9298	92A3		
			Zoom	
			TicTok	Viivo
Ø45	9296	92A1	9297	92A2
Ø58	9294	9299	9295	92A0
Ø75	92B6	92B8	92B7	92B9

¹ Installation kits are ordered separately.
For related accessories, please see page 50.

Viivo Mono Point



- 1Y - Embossed Matt Total White
- 54 - Embossed Matt White
- 65 - Embossed Matt Black
- 11 - White
- 10 - Black
- 27 - Chrome Polished

The Viivo Mono Point is a revolutionary lighting system featuring interchangeable components that are seamlessly integrated into the ceiling with a minimalist design.

Choose from recessed trim, trimless, and surface mount. Mono Point is ideal for any ceiling type and is compatible with a range of Viivo spotlights Ø35mm, Ø45mm, Ø58mm and Ø75mm. Each light head tilts up to 90° and rotates 360° horizontally.

Mix and match to create your custom arrangement; whether mounted on the wall or ceiling, it adds a dramatic and refined touch to any space.

For complete product information please visit our website.



TicTok & Viivo Mono Point

TicTok & Viivo EVO 48V Track



- 1Y - Embossed Matt Total White
- 54 - Embossed Matt White
- 65 - Embossed Matt Black
- 11 - White
- 10 - Black
- 27 - Chrome Polished

The TicTok and Viivo series is an energy-efficient EVO track system. It features an integrated driver and is designed with a focus on modularity and eco-friendly performance. The tool-free, interchangeable LED modules enable flexible design and straightforward on-site maintenance. This system offers the perfect accent lighting for sustainable projects in retail, hospitality, and high-end residential environments.

The EVO Track system is available in surface, recessed, pendant, and deep recessed designs. It supports a variety of dimming control options, allowing for a high degree of design flexibility.

For complete product information please visit our website.

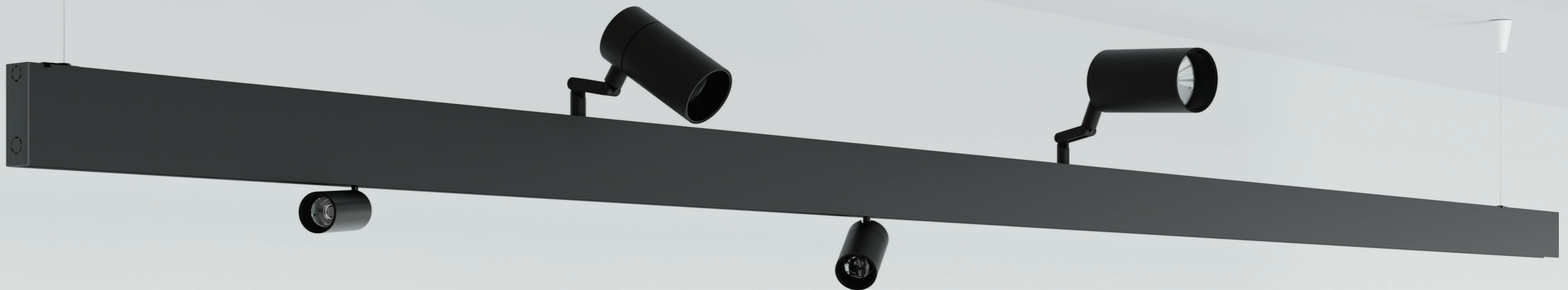

TicTok & Viivo EVO 48V Track System



For related accessories, please see page 50.



TicTok & Viivo EVO Track

TicTok & Viivo Curved EVO Track



- 1Y - Embossed Matt Total White
- 54 - Embossed Matt White
- 65 - Embossed Matt Black
- 11 - White
- 10 - Black
- 27 - Chrome Polished

The TicTok and Viivo series is an energy-efficient curved EVO track system, offering bending radii from 2 meters down to 450mm. This range ensures exceptional flexibility for custom curved designs while remaining fully compatible with the standard EVO track system.

The curved EVO track is available in surface, recessed, pendant, and deep recessed designs. It also supports CASAMBI wireless dimming, enabling seamless and integrated lighting control throughout the entire installation.

For complete product information please visit our website.

TicTok & Viivo Curved EVO 48V Track System

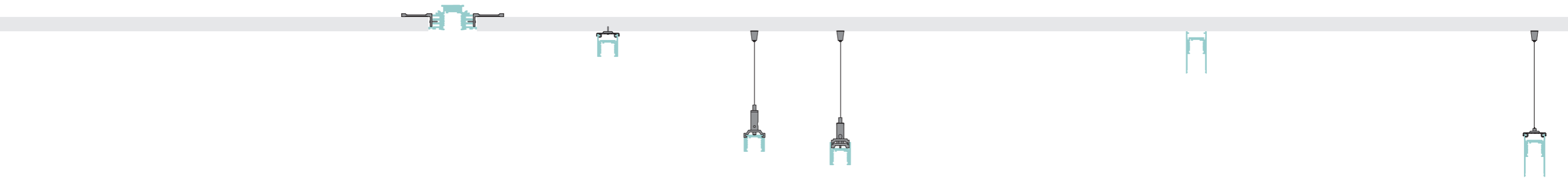

Fixture Spot light Diameter

Ø35



Ø45



Ø58



Regular Arm

Long Arm for EVO Deep Track



TicTok Viivo

96M9 96R4

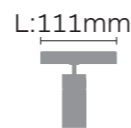

TicTok Viivo

96P7 96S0



Zoom

TicTok Viivo

96N7 96R6

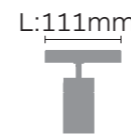

Zoom

TicTok Viivo

96Q5 96S3

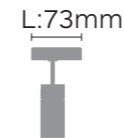

TicTok Viivo

96N3 96R5

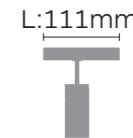

TicTok Viivo

96Q1 96S1

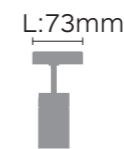

Zoom

TicTok Viivo

96N8 96S3

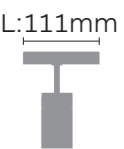

Zoom

TicTok Viivo

96Q6 96S4

96N1 96M4

96N9 96R8

96P9 96P2

96Q7 96S5

96N5 96M7

96P0 96S5

96Q3 96P5

96Q8 96S2

For related accessories, please see page 50.



TicTok & Viivo Curved EVO Track

TicTok & Viivo Micro Track



- 1Y - Embossed Matt Total White
- 54 - Embossed Matt White
- 65 - Embossed Matt Black
- 11 - White
- 10 - Black
- 27 - Chrome Polished

The TicTok and Viivo series is an energy-efficient micro track system featuring an integrated driver, emphasizing modular design and environmental sustainability. Its tool-free interchangeable LED module allows for adaptable designs and simple on-site maintenance. This system provides an ideal accent lighting solution for sustainable projects in retail, hospitality, and high-end residential spaces.

The Micro Track system offers both Casambi and DALI control compatibility. DALI dimmable fixtures can also be operated using Casambi DALI Broadcast.

For complete product information please visit our website.



TicTok & Viivo

Micro 48V

Track System

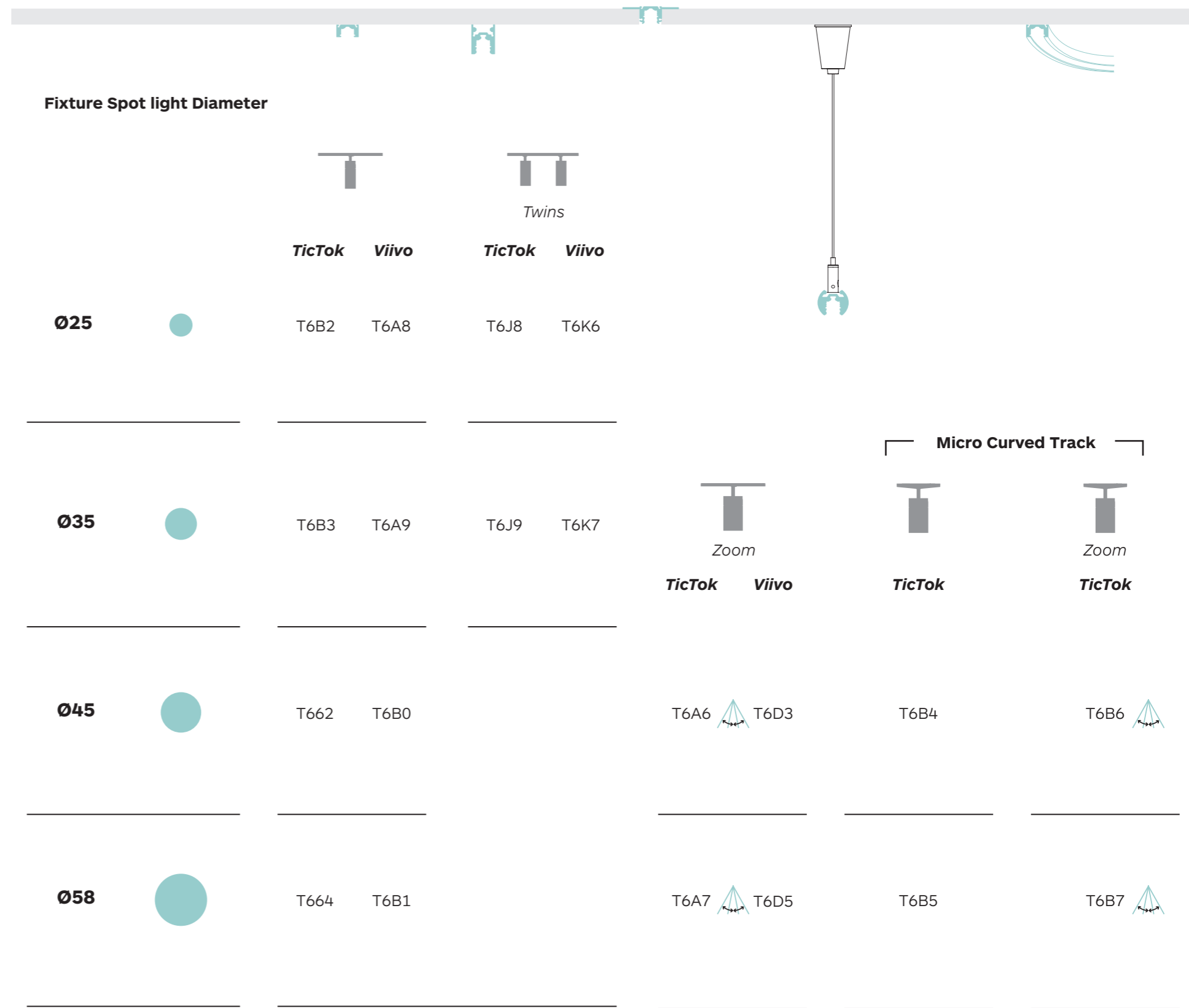

For related accessories, please see page 50.

TicTok & Vivo Micro Track



TicTok Eurotype Track

TicTok eurotype track enables users to create unique lighting schemes and configurations. Energy-saving, track mounted on a main voltage 3-phase track system, with an integrated driver in the track adaptor - the focus is on eco-friendly design and modularity. A ready-to-use solution for greater flexibility, energy efficiency, and sustainability. Available in Ø45, Ø58, and Ø75mm spot heads, with versatile aiming angle tiltable 0°-70° and rotatable 360°, Casambi or DALI control options.

TicTok is an excellent and flexible accent lighting solution for restaurants, residential spaces, retail, and galleries.

For complete product information please visit our website.



- 1Y - Embossed Matt Total White
- 54 - Embossed Matt White
- 65 - Embossed Matt Black
- 11 - White
- 10 - Black
- 27 - Chrome Polished

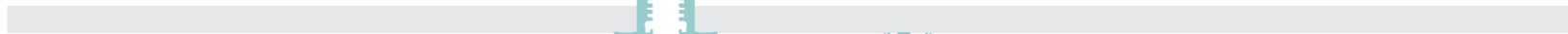

TicTok

Eurotype Track System

Fixture Spot light Diameter



Zoom

TicTok Viivo

TicTok Viivo

Ø45



6633 6675

6649  6676

Ø58



6634 6660

6650  6677

Ø75



6635 6679







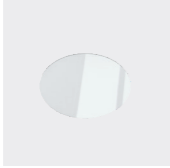

6636  6678

For related accessories, please see page 50.

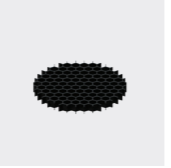
TicTok Eurotype Track

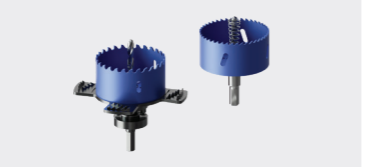

Accessories

						
Product / Accessories	Coloured Glasses Diffuser Colours 25, 42, 55, 85	Opal Diffuser	Spread Lens Colour 41	Elliptical Beam Diffuser	Wide Texture Honeycomb Louvre Colour 10	Dense Texture Honeycomb Louvre Colour 10
TicTok 25 & Vivo 25	2G57	2G59	/	2G61	2G30	2G32
TicTok 35 & Vivo 35	2G58	2G60	/	2G62	2G31	2G33
TicTok 45 ¹ & Vivo 45 ¹	2F91	2F94	2F97	2F88	2F71	2F85
TicTok 58 ¹ & Vivo 58 ¹	2F92	2F95	2F98	2F89	2F83	2F86
TicTok 75 & Vivo 75	2F93	2F96	2F99	2F90	2F84	2F87
						
Product / Accessories	Cross blade Louvre Colours 10, 17	Barn Doors Colours 10, 11	Wallwasher Cone 45° Colours 10, 17	Hole Saw <i>For mono point recessed mountings only</i>		Corner cable holder <i>For Soft track system only</i>
TicTok 25 & Vivo 25	/	/	/			
TicTok 35 & Vivo 35	/	/	/			
TicTok 45 ¹ & Vivo 45 ¹	2G01	2G04	2G07	2H95		2J17
TicTok 58 ¹ & Vivo 58 ¹	2G02	2G05	2G08			
TicTok 75 ¹ & Vivo 75 ¹	2G03	2G06	2G09			

Notes:

¹ No optical accessories are available for TicTok & Vivo 45, 58 & 75 Zoom series.

Symbols & Icons
Code system
Global presence

Symbols & Icons

48V input Class III



CLASS II
Luminaires of insulation Class II - With safety isolation, this means the tension conduction element are protected by additional isolation.



The isolation of an earth wire it is not necessary and the connection to it is not allowed.

Zoom



CASAMBI



OnBoard Dim



Degree of Ingress Protection



Interchangeable All sizes



Certification Icons

CE Mark - Product complies with CE Standard.



CSA Mark - Product complies with USA & Canada Standard.



KC Mark - Product complies with Korean Standard.



Other third party product approvals

Our products include electrical and electronic components that carry other worldwide Test House approvals such as those shown:



LED CRI

90 CRI > 90

93 CRI > 93

97 CRI > 97

98 CRI > 98

CCT-LED Colour temperature

27 Warm White 2700K

30 Warm White 3000K

35 Warm White 3500K

40 Neutral White 4000K

Dimming Options

D0 No dimming

DA DALI Dim

DC CASAMBI

D1 0-10V Dim

DN On Board Dim

Body Color



1Y Embossed matt total white (RAL 9016)



54 Embossed matt white (RAL 9016)



11 White (RAL 9003)



10 Black (RAL 9004)

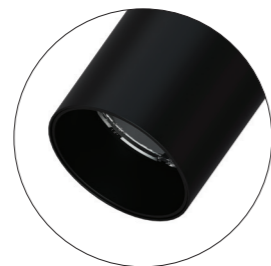

65 Embossed matt black (RAL 9017)

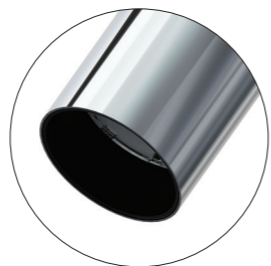

27 Chrome Polished

For the details on how to order and specific product information, please go to our website: www.formalighting.com

Global presence

Celebrating over 50 years of vision, dedication and innovation, formalighting's versatile and high-quality product offerings extends internationally via our headquarters in Hong Kong, London, Milan and Shanghai.

Our well chosen and selected partners as well as our affiliated international offices broaden our global presence further in markets such as USA, Australia, Japan, South East Asia, India and the Middle East.

Through our commitment to growth and investment within formalighting's professional team, infrastructure and product ranges, we are able to provide increasing service to our global retail and hospitality clients as well as lighting designers and specifiers strengthening our position as a leading international supplier of innovative architectural lighting solutions and systems.

With over 50 years' experience in designing and manufacturing architectural lighting, formalighting's comprehensive portfolio offers a competitive range of European designed and expertly engineered products that carry CB, CE, CCC and UL certifications.

Furthermore formalighting's latest award-winning motorized range of track, pendant, and recessed fixtures, featuring remote-controlled adjustable pan and tilt, dim, dim to warm, tuneable white and beam shaping lens, are available worldwide incorporating the latest, most advanced lighting technologies.

MILAN

EUROPE HEADQUARTERS

Tel (+39) 02 9354 0300

Fax (+39) 02 9343 5117

E- mail info-europe@formalighting.com

HONG KONG

ASIA HEADQUARTERS

Tel (+852) 2516 6500

Fax (+852) 2516 6525

E- mail info-asia@formalighting.com

NEW YORK

LOCAL SALES OFFICE

E- mail info-us@formalighting.com

SHANGHAI

LOCAL SALES OFFICE

E- mail info-china@formalighting.com

LONDON

LOCAL SALES OFFICE

E- mail info-uk@formalighting.com

AUSTRALIA

LOCAL SALES OFFICE

Tel (+61) 488 567 388

E- mail info-australia@formalighting.com

INDIA

LOCAL SALES OFFICE

Tel (+91) 9686351257

E- mail info-india@formalighting.com

formalighting is constantly developing and improving its products therefore all information, drawings illustrations, specifications, photometric values in this catalogue are indicatives and shall not form part of any commitment by our company that reserves the right to change specifications without prior notification or public announcement.

Technical information on the installation-instruction has precedence over the information in the catalogue.

Our general terms and conditions shall apply notwithstanding any stipulation on the contrary to all the orders and agreement with formalighting. You can obtain a copy of these conditions on demand.

Publication date: April 2026

©Copyright formalighting

With thanks to all contributors for the realization of this catalogue

Designed by formalighting's Graphic Design Department

No part of this catalogue may be copied without written authorization of formalighting

TicTok & Viivo Series 2026

formalighting

MILAN

-

LONDON

-

USA

-

HONG KONG

-

SHANGHAI

-

INDIA

www.formalighting.com