

formalighting

TicTok & Viivo Mono Point Series

2025 | 26

TicTok & Viivo The Mono Point Series

Surface

Recessed

Rear access

Viivo Series

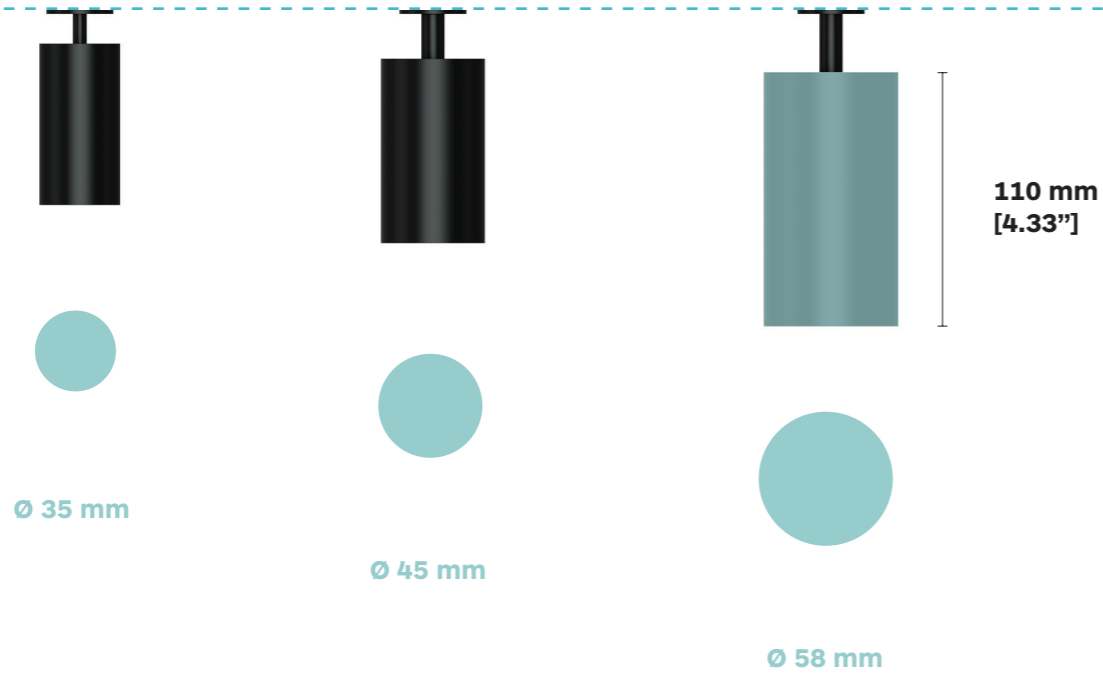
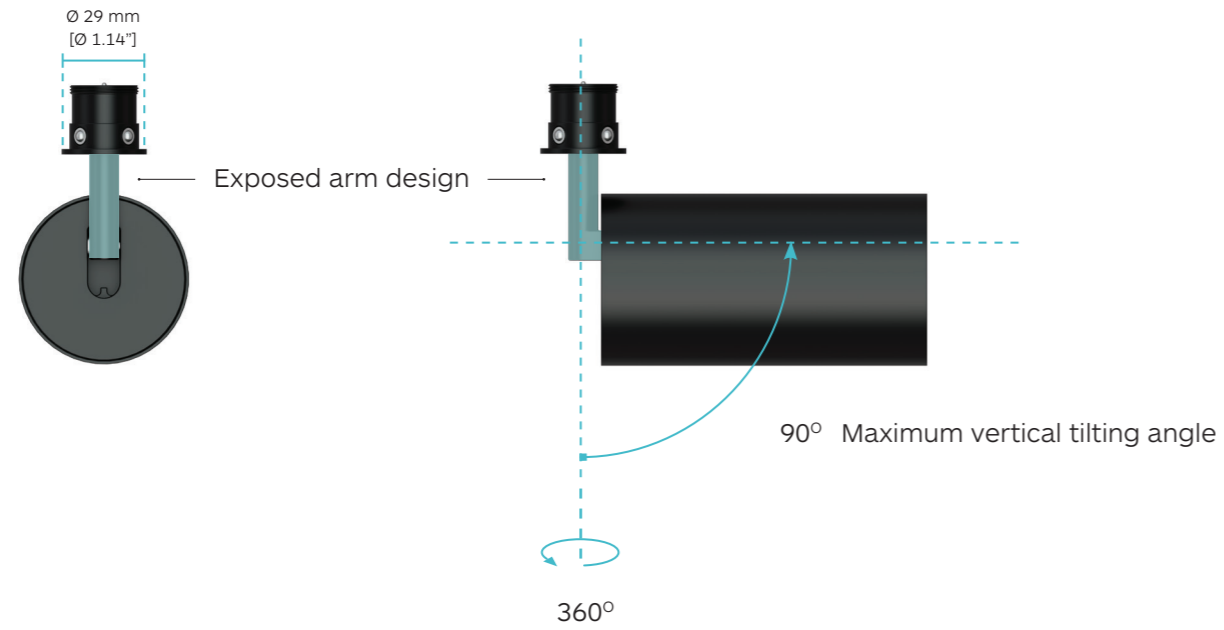

TicTok Series

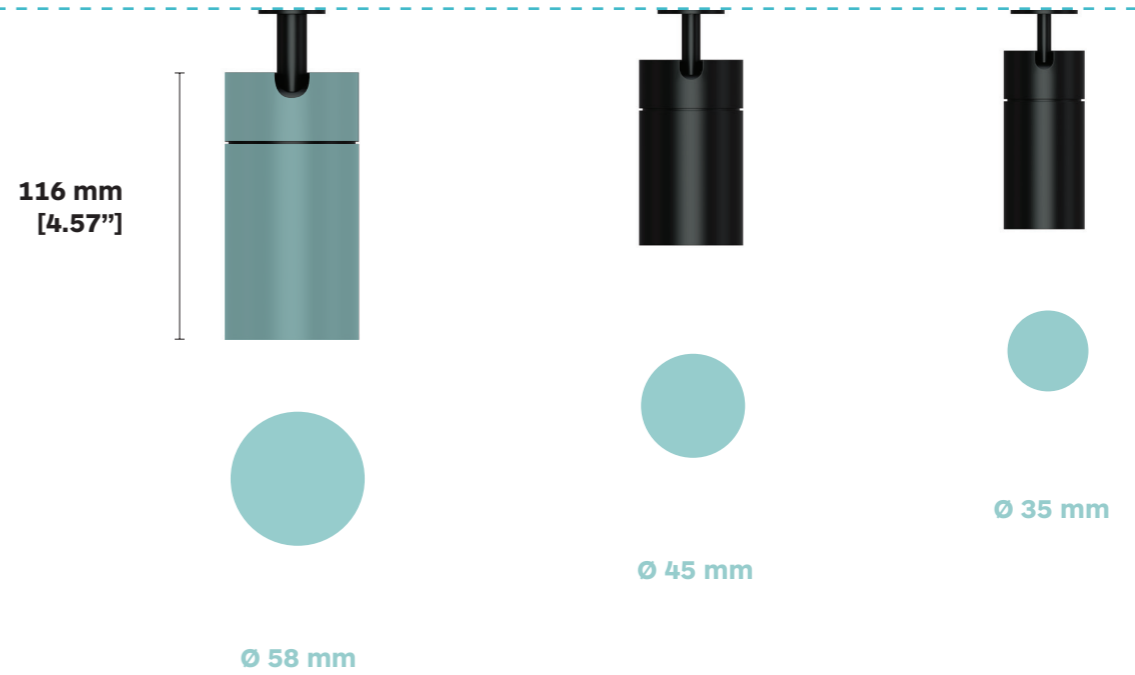
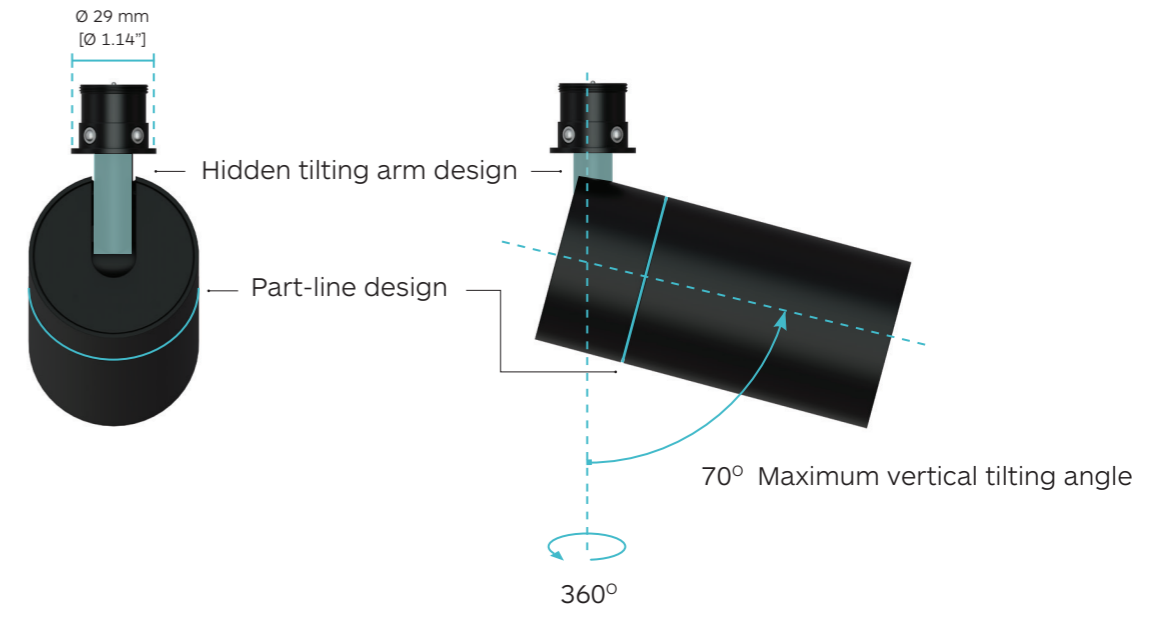

Mono Point Index

Surface
Mounting



**Mounting
Options**

Page 8



Recessed
Trimless



Recessed
Trim



Fixture Options

TicTok Series - Page 12 - 15
Viivo Series - Page 16 - 19

Recessed Trimless
rear access



Decorative Cover
(Included with mount)



**Optical
Accessories**

Page 20

Mono Point Mounting Options



Choose your **mounting option**

Surface Mounting

Art. 2H87¹



Min. 10 mm, Max. 30 mm
[Min. 0.93"], [Max. 1.18"]

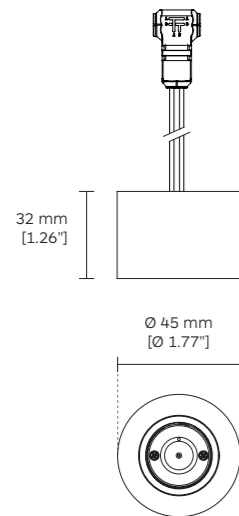

Recessed Trim

Art. 2H93¹

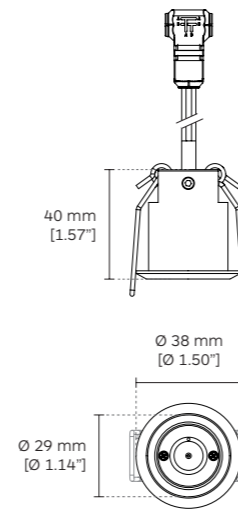

Recessed Trimless

Art. 2H92¹

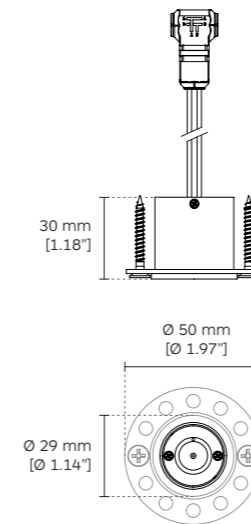

Recessed Trimless rear access

Art. 2H86¹

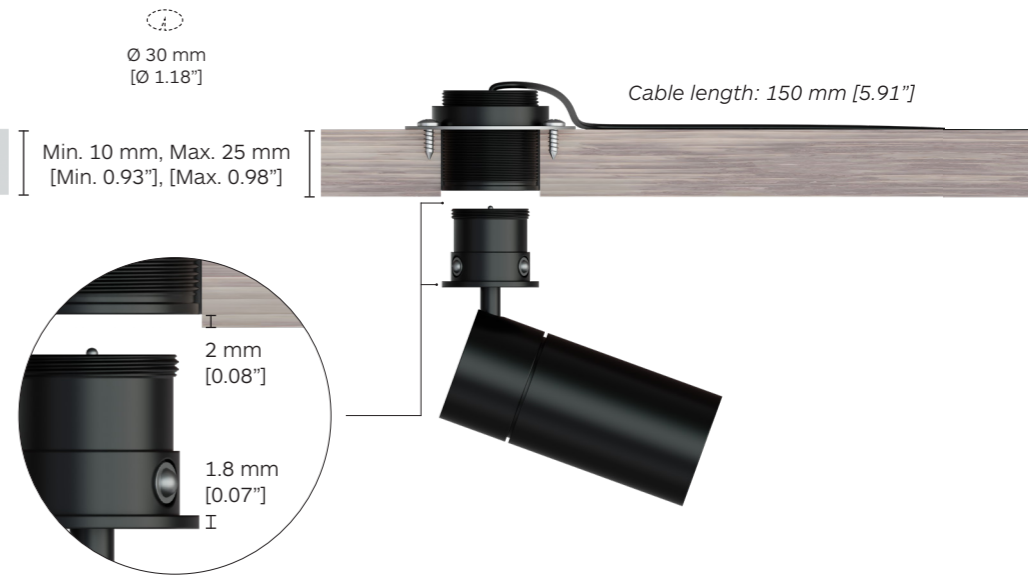

Ø 30 mm
[Ø 1.18"]
Min. 10 mm, Max. 25 mm
[Min. 0.93"], [Max. 0.98"]

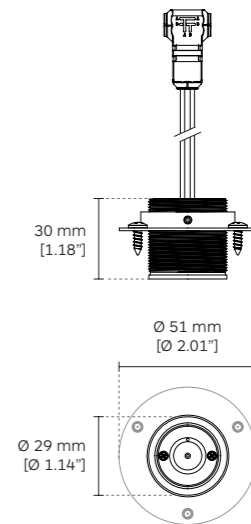

Cable length: 150 mm [5.91"]

¹ Mounting options are ordered separately.

TicTok & Viivo Mono Point

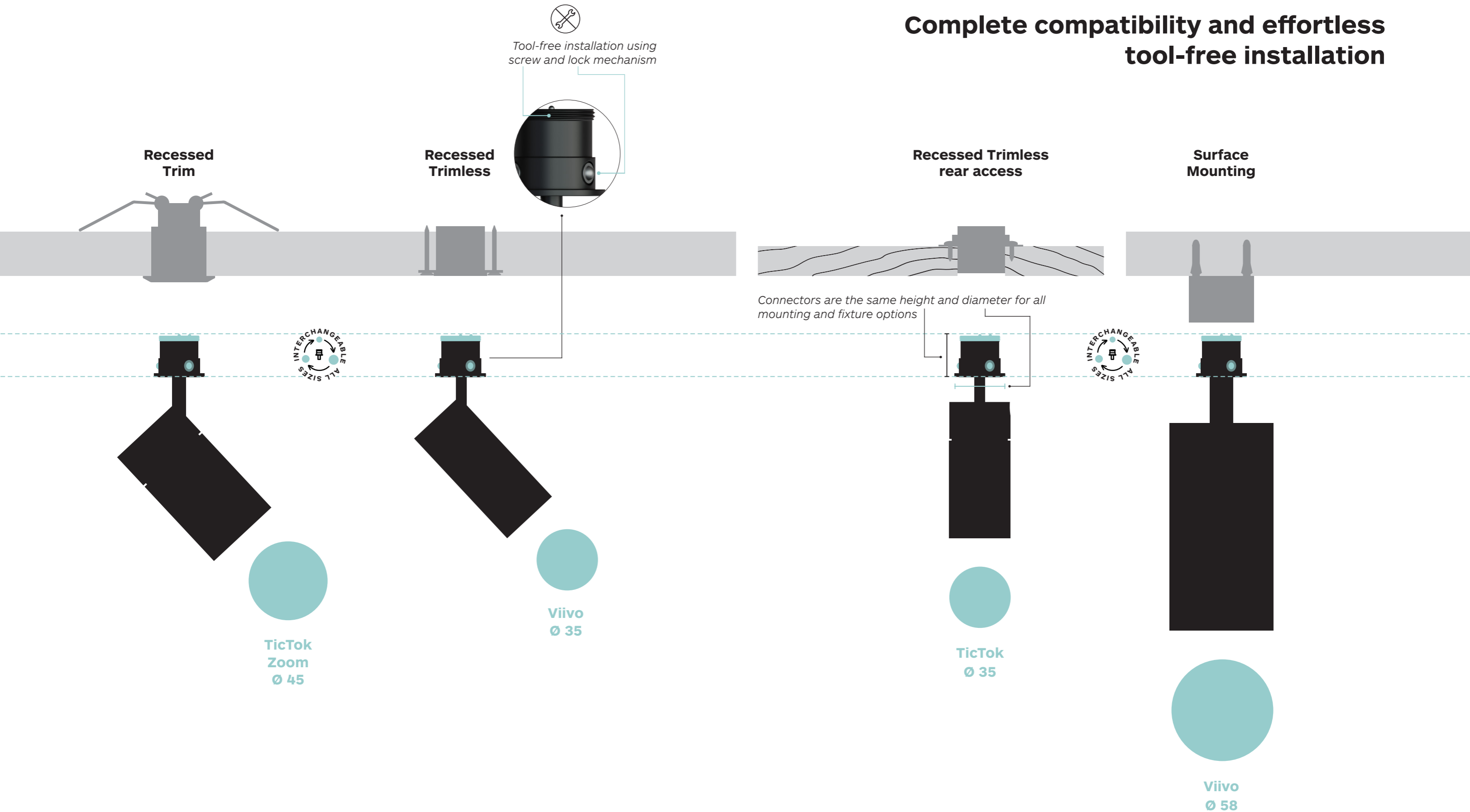

TicTok Mono Point

35 | 45 | 58 | Zoom 45 & 58

The TicTok Mono Point is a revolutionary lighting system featuring interchangeable components that are seamlessly integrated into the ceiling with a minimalist design.

Choose from recessed trim, trimless, and surface mount. Mono Point is ideal for any ceiling type and is compatible with a range of TicTok spotlights Ø35mm, Ø45mm and Ø58mm. Each light head tilts up to 70° and rotates 360° horizontally.

Mix and match to create your custom arrangement; whether mounted on the wall or ceiling, it adds a dramatic and refined touch to any space.



LED Sources:

High Efficacy:
CRI: 90 | CCT: 2700K, 3000K, 3500K, 4000K.

High Rendering:
CRI: 97 | CCT: 2700K, 3000K, 3500K, 4000K.

Accessories:

- Wide & Dense Texture Honeycomb Louvre
 - Elliptical Beam Diffuser
 - Coloured Glasses Diffuser
 - Opal Lens
 - Spread Lens
 - Cross blade Louvre
 - Barn doors
 - Wallwasher Cone 45°
- Please see page 14 for details.

- 1Y - Embossed Matt Total White
- 54 - Embossed Matt White
- 65 - Embossed Matt Black
- 11 - White
- 10 - Black
- 27 - Chrome Polished

TicTok Mono Point

35 | 45 | 58 | Zoom 45 & 58



9298

9296 / 9297

9294 / 9295

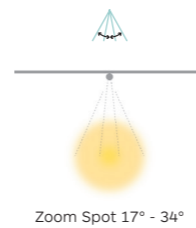
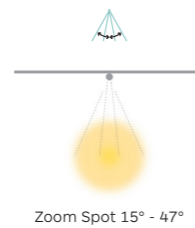
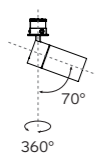
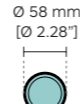
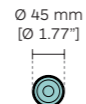
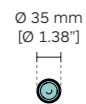
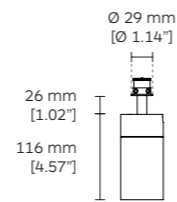
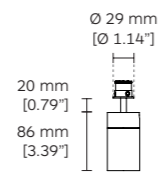
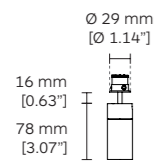

CRI > 90
3000K High Efficacy

	Fixture Code ¹	LED Module Code	LED Power	Nominal Lumen	Beam Angle (BA°)	Dimming Options ³	CCT Options ²
TicTok 35	9298	E013	5W	691 lm	20° / 24° / 38°	DO No Dim	27 2700K
TicTok 45	9296	JC02	10W	969 lm	12°	DC CASAMBI	30 3000K
			9W	1101 lm	18° / 26° / 38°		35 3500K
TicTok Zoom 45	9297	E077	5.5W	634 lm	BS (15°- 47°)		40 4000K
TicTok 58	9294	JC01	15W	1632 lm	12° / 18°		
			14W	1730 lm	24° / 34°		
TicTok Zoom 58	9295	E030	15W	1632 lm	BS (17°- 34°)		

CRI > 97
3000K High Rendering

TicTok 35	9298	E013	5W	620 lm	20° / 24° / 38°		
TicTok 45	9296	JC02	10W	922 lm	12°		
			9W	975 lm	18° / 26° / 38°		
TicTok Zoom 45	9297	E077	5.5W	606 lm	BS (15°- 47°)		
TicTok 58	9294	JC01	15W	1418 lm	12° / 18°		
			14W	1590 lm	24° / 34°		
TicTok Zoom 58	9295	E030	15W	1418 lm	BS (17°- 34°)		

¹ For complete code ordering information, please see page 25. ² Other CCT options available on request.
³ 0-10V / DALI / Phase dimming options are available as group dimming. Please see page 22 for more details.
48V Power Supply to be ordered separately, please see page 21 for more details.
For the most updated product information, please go to our website.

BS = Beam Shaping, Ordering code; **BS**.

Viivo Mono Point

35 | 45 | 58 | Zoom 45 & 58

The Viivo Mono Point is a revolutionary lighting system featuring interchangeable components that are seamlessly integrated into the ceiling with a minimalist design.

Choose from recessed trim, trimless, and surface mount. Mono Point is ideal for any ceiling type and is compatible with a range of Viivo spotlights Ø35mm, Ø45mm and Ø58mm. Each light head tilts up to 90° and rotates 360° horizontally.

Mix and match to create your custom arrangement; whether mounted on the wall or ceiling, it adds a dramatic and refined touch to any space.



LED Sources:

High Efficacy:
CRI: 90 | CCT: 2700K, 3000K, 3500K, 4000K.

High Rendering:
CRI: 97 | CCT: 2700K, 3000K, 3500K, 4000K.

Accessories:

- Wide & Dense Texture Honeycomb Louvre
 - Elliptical Beam Diffuser
 - Coloured Glasses Diffuser
 - Opal Lens
 - Spread Lens
 - Cross blade Louvre
 - Barn doors
 - Wallwasher Cone 45°
- Please see page 14 for details.



- 1Y - Embossed Matt Total White
- 54 - Embossed Matt White
- 65 - Embossed Matt Black
- 11 - White
- 10 - Black
- 27 - Chrome Polished

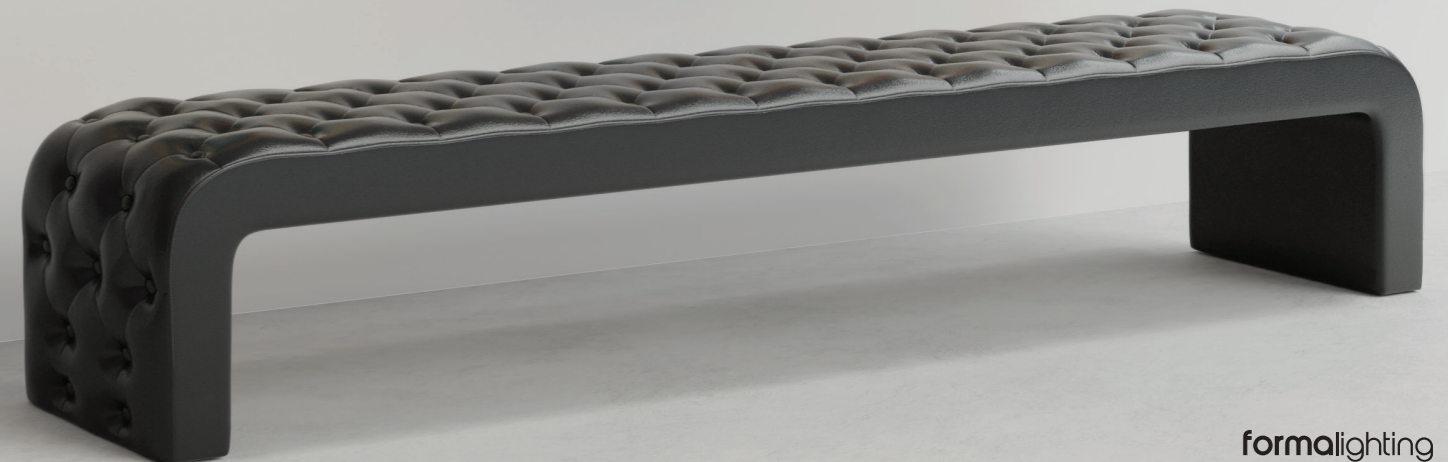
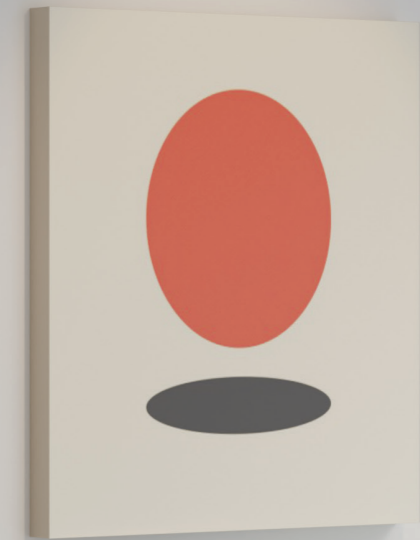

Viivo Mono Point

35 | 45 | 58 | Zoom 45 & 58



92A3

92A1 / 92A2

9299 / 92A0

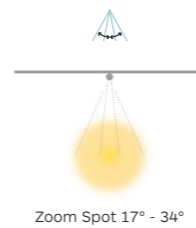
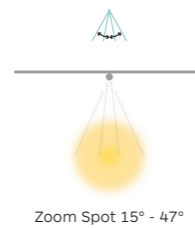
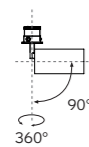
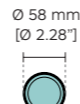
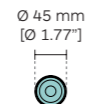
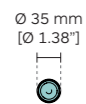
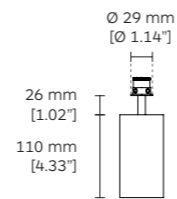
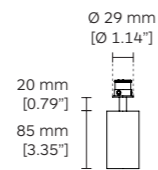
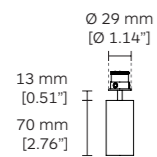

CRI > 90
3000K High Efficacy

	Fixture Code ¹	LED Module Code	LED Power	Nominal Lumen	Beam Angle (BA) ²	Dimming Options ³	CCT Options ²
Viivo 35	92A3	E013	5W	691 lm	20° / 24° / 38°	D0 No Dim	27 2700K
Viivo 45	92A1	JC02	10W	969 lm	12°	DC CASAMBI	30 3000K
			9W	1101 lm	18° / 26° / 38°		35 3500K
Viivo Zoom 45	92A2	E077	5.5W	634 lm	BS (15°- 47°)		40 4000K
Viivo 58	9299	JC01	15W	1632 lm	12° / 18°		
			14W	1730 lm	24° / 34°		
Viivo Zoom 58	92A0	E030	15W	1632 lm	BS (17°- 34°)		



CRI > 97
3000K High Rendering



Viivo 35	92A3	E013	5W	620 lm	20° / 24° / 38°		
Viivo 45	92A1	JC02	10W	922 lm	12°		
			9W	975 lm	18° / 26° / 38°		
Viivo Zoom 45	92A2	E077	5.5W	606 lm	BS (15°- 47°)		
Viivo 58	9299	JC01	15W	1418 lm	12° / 18°		
			14W	1590 lm	24° / 34°		
Viivo Zoom 58	92A0	E030	15W	1418 lm	BS (17°- 34°)		

¹ For complete code ordering information, please see page 25. ² Other CCT options available on request.
³ 0-10V / DALI / Phase dimming options are available as group dimming. Please see page 22 for more details.
48V Power Supply to be ordered separately, please see page 21 for more details.
For the most updated product information, please go to our website.

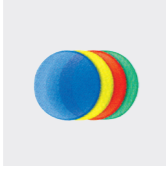
BS = Beam Shaping, Ordering code; **BS**.

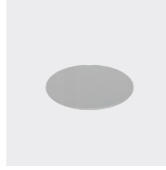
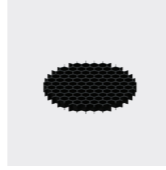
Optical Accessories

					
Product / Optical Accessories	Coloured Glasses Diffuser 25, 42, 55, 85	Opal Lens Colour 41	Spread Lens Colour 41	Elliptical Beam Diffuser Colour 41	Wide Texture Honeycomb Louvre Colour 10
TicTok 35 & Viivo 35	2G58	2G60	/	2G62	2G31
¹ TicTok 45 & Viivo 45	2F91	2F94	2F97	2F88	2F71
¹ TicTok 58 & Viivo 58	2F92	2F95	2F98	2F89	2F83

				
Product / Optical Accessories	Dense Texture Honeycomb Louvre Colour 10	Cross blade Louvre Colours 10, 17	Barn Doors Colours 10, 11	Wallwasher Cone 70° Colours 10, 17
TicTok 35 & Viivo 35	2G33	/	/	/
¹ TicTok 45 & Viivo 45	2F85	2G01	2G04	2G07
¹ TicTok 58 & Viivo 58	2F86	2G02	2G05	2G08

¹ No optical accessories are available for TicTok & Viivo 45, 58 Zoom series.

Driver Options & Wiring Diagram

Driver Options

No Dim

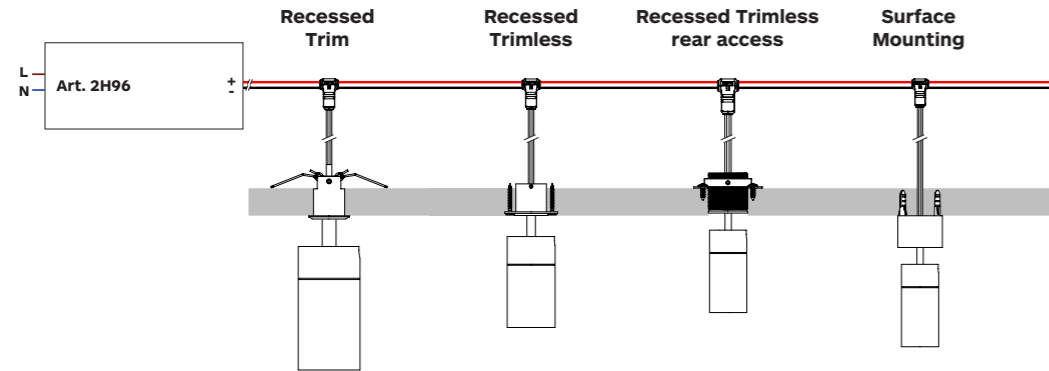

CASAMBI Dim

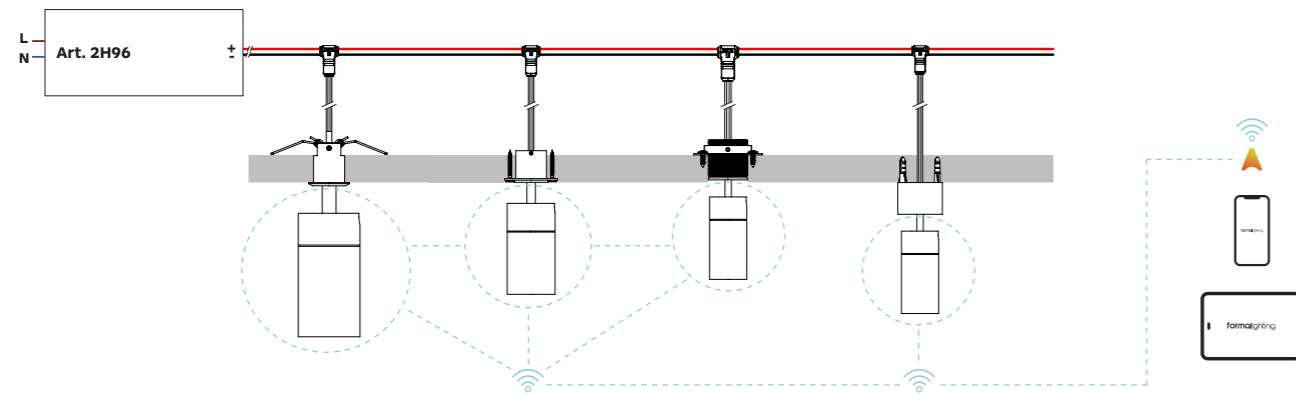

DALI Dim

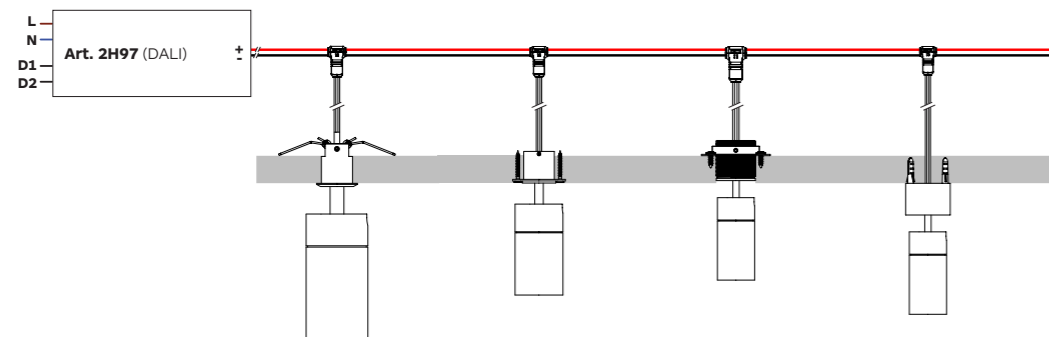

0-10V Dim

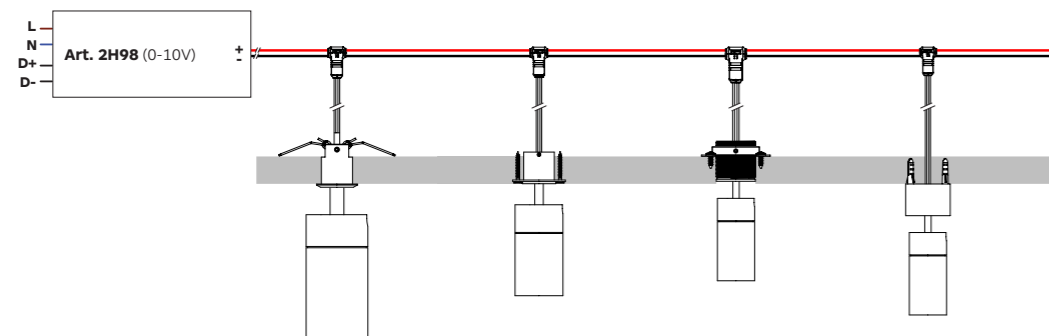

Power Supply

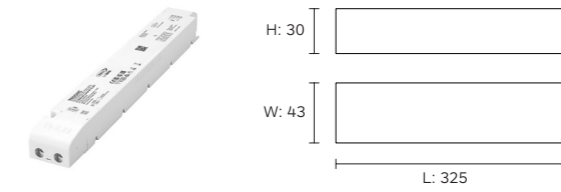

	220-240VAC input, 48VDC output 200w power supply	220-240VAC input, 48VDC output 200w power supply DALI Dimming	220-240VAC input, 48VDC output 200w power supply 0-10V Dimming
Code	2H96	2H97	2H98
Size	43 x 325 x 30	43 x 325 x 30	43 x 325 x 30

48V Power Supply to be ordered separately.

LED Modules & Lens compatibility

LED Modules & Lens compatibility

TicTok x Viivo Mono Point

Product compatibility	LED Module	CRI	LED Power	LENS Compatibility Code			
				20°	24°	38°	
TicTok 35 Mono Point Code: 9298	E013	CRI> 90	5W	L024	L025	L026	
		CRI> 97	5W				
Viivo 35 Mono Point Codes: 92A3							
TicTok 45 Mono Point Code: 9296	JC02	CRI> 90	9W	/	L043	L044	L045
		CRI> 90	10W	L043	/	/	/
	JC02	CRI> 97	9W	/	L043	L044	L045
		CRI> 97	10W	L043	/	/	/
Viivo 45 Mono Point Codes: 92A1							
TicTok 58 Mono Point Code: 9294	JC01	CRI> 90	14W	/	/	L041	L042
		CRI> 90	15W	L040	L041	/	/
	JC01	CRI> 97	14W	/	/	L041	L042
		CRI> 97	15W	L040	L041	/	/
Viivo 58 Mono Point Code: 9299							
TicTok 45 Zoom Mono Point Code: 9297	E077	CRI> 90 CRI> 97	5.5W	BS (15° - 47°)			
Viivo 45 Zoom Mono Point Code: 92A1							
TicTok 58 Zoom Mono Point Code: 9295	E030	CRI> 90 CRI> 97	15W	BS (17° - 34°)			
Viivo 58 Zoom Mono Point Code: 92A0							

Symbols & Icons
Code system
Global presence

Symbols & Icons

Round ceiling cut



Square ceiling cut



Zoom



CLASS I

Luminaire of insulation Class I - with earth connector.



CLASS II

Luminaire of insulation Class II - With safety isolation, this means the tension conduction element are protected by additional isolation. The isolation of an earth wire it is not necessary and the connection to it is not allowed.



CLASS III

Luminaire of insulation Class III - designed for operation of protected low voltage supplied (>42V).



Degree of Ingress Protection*



48V input integrated.



Certification Icons

CE Mark - Product complies with CE Standard.



UL Mark - Product complies with USA & Canada Standard.



CSA Mark - Product complies with USA & Canada Standard.



CB Mark - Product complies with CB Standard.



KC Mark - Product complies with Korean Standard.



Other third party product approvals

Our products include electrical and electronic components that carry other worldwide Test House approvals such as those shown:



Body Color



1Y Embossed matt total white (RAL 9016)



54 Embossed matt white (RAL 9016)

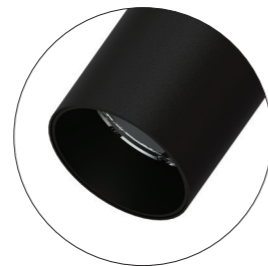

65 Embossed matt black (RAL 9017)



11 White (RAL 9003)

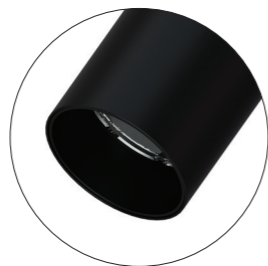

10 Black (RAL 9004)

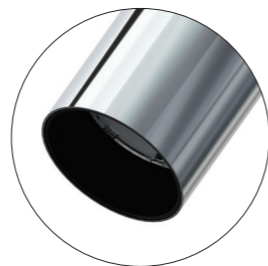

27 Chrome Polished

Code system

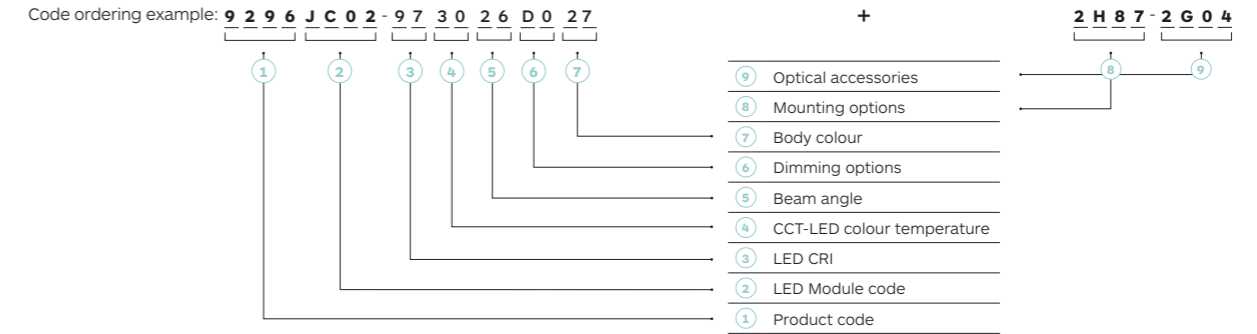

LED CRI	CCT-LED Colour temperature	Dimming Options	Body Colour	Mounting options	Ø 35	Ø 45	Ø 58	Optical accessories	
90 CRI > 90	27 Warm White 2700K	D0 No Dim	1Y Embossed matt total white RAL (9016)	2H87 Surface Mounting	2G33	2F85	2F86	Dense Texture Honeycomb Louvre	
97 CRI > 97	30 Warm White 3000K	DC CASAMBI	54 Embossed matt white RAL (9016)	2H93 Recessed Trim	/	2G01	2G02	Cross blade Louvre	
	35 Warm White 3500K		65 Embossed matt black RAL (9017)	2H92 Recessed Trimless	/	2G04	2G05	Barn Doors	
	40 Neutral White 4000K		11 White RAL (9003)	2H86 Recessed Trim Rear access	/	2G07	2G07	Wallwasher Cone 70°	
			10 Black RAL (9004)			2G58	2F91	2F92	Coloured Glasses Diffuser
			27 Chrome Polished			2G60	2F94	2F95	Opal Lens
						/	2F97	2F98	Spread Lens
						2G62	2F88	2F89	Elliptical Beam Diffuser
						2G31	2F71	2F83	Wide Texture Honeycomb Louvre

How to order

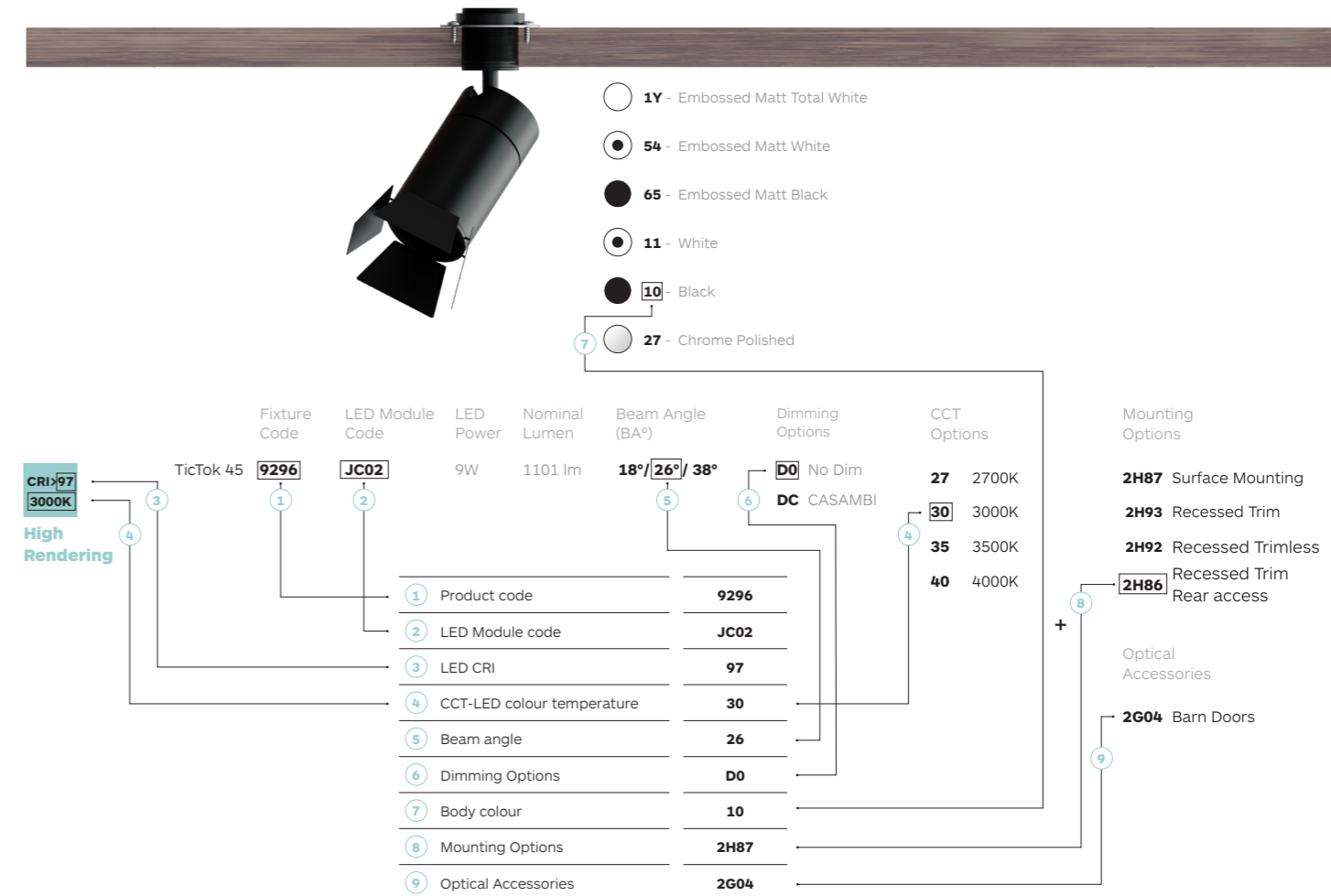

Global presence

Celebrating over 50 years of vision, dedication and innovation, formalighting's versatile and high-quality product offerings extends internationally via our headquarters in Hong Kong, London, Milan and Shanghai.

Our well chosen and selected partners as well as our affiliated international offices broaden our global presence further in markets such as USA, Australia, Japan, South East Asia, India and the Middle East.

Through our commitment to growth and investment within formalighting's professional team, infrastructure and product ranges, we are able to provide increasing service to our global retail and hospitality clients as well as lighting designers and specifiers strengthening our position as a leading international supplier of innovative architectural lighting solutions and systems.

With over 50 years' experience in designing and manufacturing architectural lighting, formalighting's comprehensive portfolio offers a competitive range of European designed and expertly engineered products that carry CB, CE, CCC and UL certifications.

Furthermore formalighting's latest award-winning motorized range of track, pendant, and recessed fixtures, featuring remote-controlled adjustable pan and tilt, dim, dim to warm, tuneable white and beam shaping lens, are available worldwide incorporating the latest, most advanced lighting technologies.

MILAN

EUROPE HEADQUARTERS

Tel (+39) 02 9354 0300

Fax (+39) 02 9343 5117

E- mail info-europe@formalighting.com

HONG KONG

ASIA HEADQUARTERS

Tel (+852) 2516 6500

Fax (+852) 2516 6525

E- mail info-asia@formalighting.com

NEW YORK

LOCAL SALES OFFICE

E- mail info-us@formalighting.com

SHANGHAI

LOCAL SALES OFFICE

E- mail info-china@formalighting.com

LONDON

LOCAL SALES OFFICE

E- mail info-uk@formalighting.com

AUSTRALIA

LOCAL SALES OFFICE

Tel (+61) 488 567 388

E- mail info-australia@formalighting.com

INDIA

LOCAL SALES OFFICE

Tel (+91) 9686351257

E- mail info-india@formalighting.com

formalighting is constantly developing and improving its products therefore all information, drawings illustrations, specifications, photometric values in this catalogue are indicatives and shall not form part of any commitment by our company that reserves the right to change specifications without prior notification or public announcement.

Technical information on the installation-instruction has precedence over the information in the catalogue.

Our general terms and conditions shall apply notwithstanding any stipulation on the contrary to all the orders and agreement with formalighting. You can obtain a copy of these conditions on demand.

Publication date: November 2025

©Copyright formalighting

With thanks to all contributors for the realization of this catalogue

Designed by formalighting's Graphic Design Department

No part of this catalogue may be copied without written authorization of formalighting

formalighting

HONG KONG

-

LONDON

-

MILAN

-

SHANGHAI

-

USA

-

INDIA